

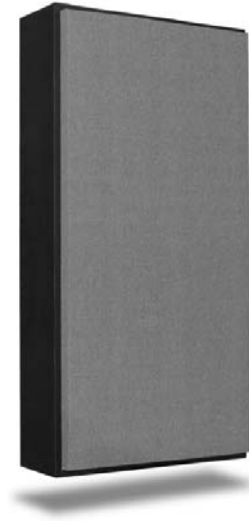

FullTrap

INSTALLATION MANUAL



Congratulations on purchasing the FullTrap from Primacoustic. The FullTrap is an easy to assemble bass trap that will effectively absorb a wide bandwidth of frequencies and look great for many years to come. Please take a few minutes to read through this assembly manual. It will give you a list of included parts, as well as step by step assembly and wall mounting instructions. Please refer to www.primacoustic.com/appnotes for various placement options, benefits, and general room acoustics information. Should you have any questions or comments, we invite you to send an email to: info@primacoustic.com.

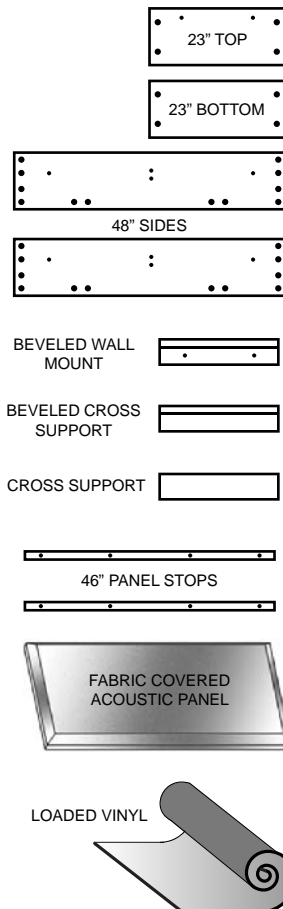

TOOLS REQUIRED:

- Medium sized Phillips screwdriver
- 48" Bubble Level and small bubble level
- Wall Stud finder (recommended)
- Cordless Drill (recommended for installing drywall anchors)

BOX CONTENTS:

Before beginning assembly, please take a moment to familiarize yourself with the box contents. It will include:

- | (QTY) | Description: |
|-------|-----------------------------------|
| (2) | 48" Black frame side sections |
| (1) | 23" Black frame 'Top' section |
| (1) | 23" Black frame 'Bottom' section |
| (2) | 46" Panel Stops |
| (1) | 23" Beveled Wall Mount Stretchers |
| (1) | 23" Beveled Cross Support |
| (1) | 23" Cross Support |
| (1) | Fabric wrapped fiberglass panel |
| (1) | Loaded vinyl barrier |

HARDWARE BAG CONTENTS

- | (QTY) | Description: |
|-------|--------------------------------|
| (8) | Cams-locks |
| (8) | Cam-pins |
| (8) | Wooden Dowels |
| (8) | Medium Phillips Screws |
| (8) | Short Phillips Pan Head Screws |
| (2) | Long Phillips Pan Head Screws |
| (2) | Heavy Duty Phillips Screws |
| (2) | Plastic Drywall Anchors |

Warranty: Please inspect panels immediately after purchase and before mounting. Primacoustic Broadway acoustic panels are guaranteed to be free of manufacturing defects for a period of thirty (30) days after purchase. In the unlikely event that a defect is uncovered, please call 604-942-1001 to obtain an RA number (Return Authorization number) from Primacoustic before the thirty (30) day warranty period expires. Once you have obtained an RA number you must return the product, freight prepaid, within fifteen (15) days after the date the RA number is issued. Please return the product in the original packaging (or another, affording an equal degree of protection) with all of the following: (1) RA number clearly marked on the returned package; (2) a receipt or bill of sale showing proof of purchase from an authorized retail seller; and (3) a written note describing the defect and including your name, address, telephone number and the applicable RA number. You are solely responsible for all shipping and insurance costs for returning the product to Primacoustic, and you will not be reimbursed or compensate for any loss or damage incurred during return shipping. Primacoustic will at its discretion repair or replace the panel. Should the panel be no longer available, Primacoustic reserves the right to exchange this with a panel of similar performance and value. Due to different dye lots, Primacoustic cannot guarantee exact color match. This Warranty shall solely extend to the original owner and is limited to manufacturing defects and excludes any damage due to wear and tear, abuse, misuse, misapplication, color fading or deterioration due to prolonged exposure to ultra violet light, smoke, humidity or other environmental factors. It is understood that the use and suitability of Broadway is entirely the responsibility of the buyer or specifying engineer and as such, these parties agree to hold Primacoustic, or it's associated company, and/or officers, harmless from any responsibility whatsoever other than what is clearly outlined in this warranty.

FRAME ASSEMBLY INSTRUCTIONS

- 1** Place the two 48" side sections on the floor with the pre-drilled holes facing up. For each side section push eight wooden dowels into the pre-drilled holes.

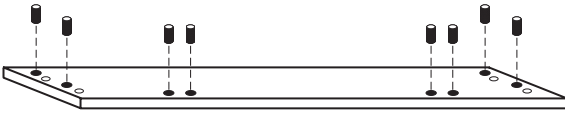

For each side section thread four cam-pins into the holes at the ends as shown.

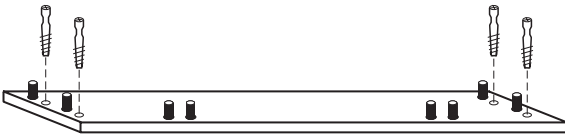

Place the two the 23" top and bottom sections on the floor with the pre-drilled holes facing up. Push four cam-locks into the pre-drilled cavities on the 23" top and bottom sections. Ensure the open side of the cam-lock, marked with an arrow head, is facing toward the edge so it can mate with the cam-pin.

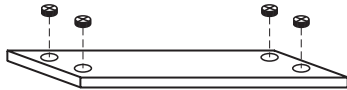

- 2** Connect the 23" top and bottom sections to a 48" side section. Note the 23" top section has small *piolet holes drilled along the front edge*. Use a Phillips screwdriver to tighten the cams snugly.

If the cam-locks won't tighten ensure the arrow head is facing outward so the cam-pins line up with the cam-locks.

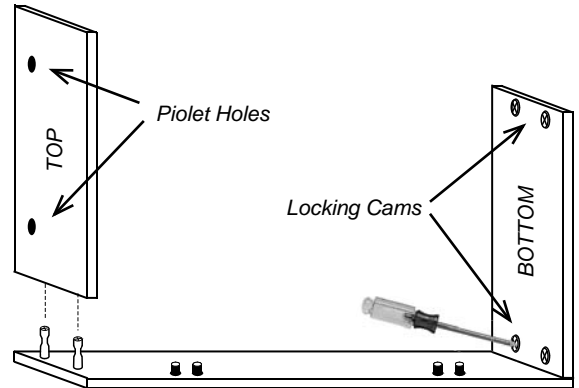

- 3** Set the cross support with the beveled edge onto the wooden dowels near the top section. Be sure that the beveled edge is facing inward and toward the bottom section (see diagram). The beveled cross support is used to wall mount the completed FullTrap.

Set the cross support with the square edge onto the wooden dowels near the bottom section.

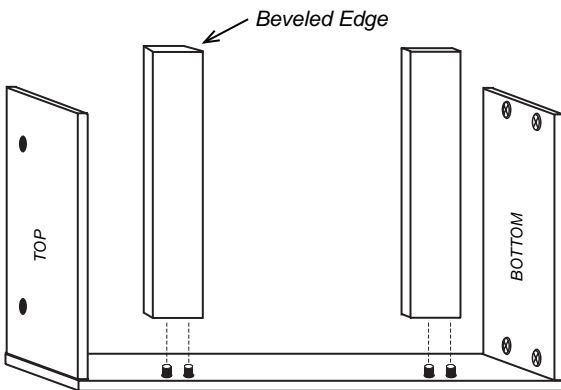

- 4** Set the other 48" side section onto the frame assembly being care full to line up the cam-pins and dowels. Tighten all cams snugly using a Phillips screwdriver.

Lay the completed frame down so the front is facing up.

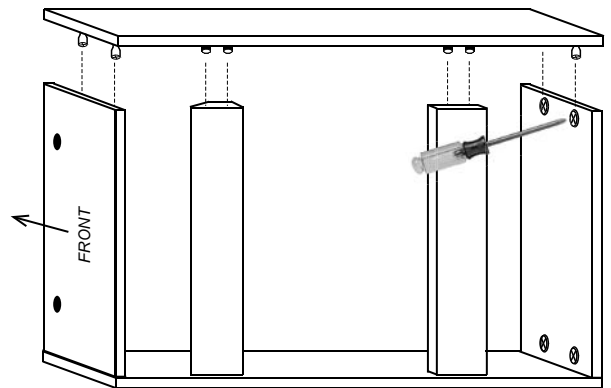

VINYL BARRIER ASSEMBLY

- 5** Set two panel stops with the four small piolet holes facing up, and larger pre-drilled holes facing sideways. Lay the vinyl material on top of the panel stops. Line up the edges flush and keep the vinyl material square with the panels stops (diagram).

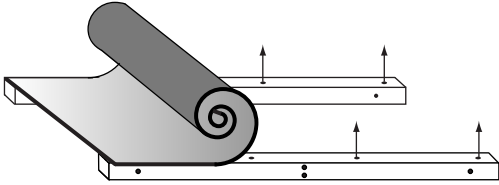

Using eight short Phillips pan head screws fasten the vinyl material to the panel stops. Screw through the vinyl into the small piolet holes (diagram). Avoid stretching the vinyl between screws. It should lay flat and limp between screws.

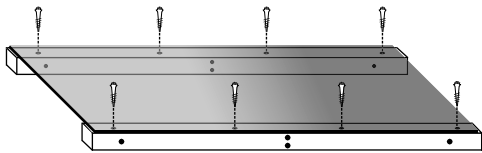

- 7** Lower in the Broadway fiberglass panel with the fabric covering facing outward. The panel should fit snugly. Do not force the panel into place.

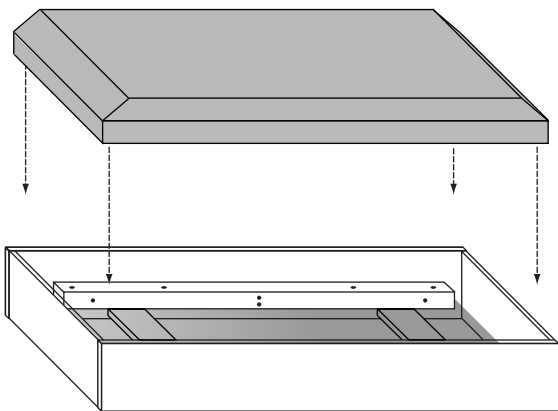

- 6** With the frame assembly lying down on it's back. Set the vinyl barrier assembly into the frame with the panel stops facing upward (diagram).t

Using eight medium Phillips screws, attach panel stops into the pre-drilled hole locations on the inside of the 48" side sections (diagram).

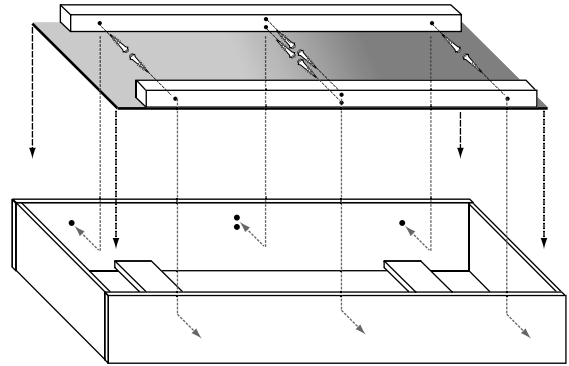

- 8** Fasten the Broadway fiberglass panel at the top end with two Philips pan head screws through the pre-drilled holes in the 23" top section. This will prevent the panel from becoming accidentally dislodged.

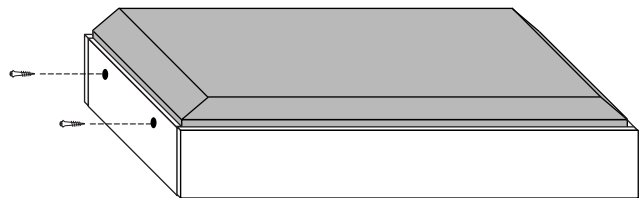

WALL MOUNTING INSTRUCTIONS

Select the location where you would like to hang your FullTrap. Ideally, the center of the FullTrap should be positioned at the same height as your ears when seated in your listening position but this is flexible if room decor or listening position dictates otherwise.

Mark the wall where the top of the FullTrap will be. Measure down from that line 12 inches and mark the top of the wall support position. Use a bubble level and pencil to make a straight horizontal line that will guide you in mounting the wall support level.

The FullTrap should be screwed into the wall studs. Locate and mark two wall studs that are 12" to 16" apart. A stud finder is recommended for this.

Alternatively, use wall anchors capable of supporting at least 55lbs. For sheetrock walls 1/4" toggle bolts are recommended. For masonry and cement block use an appropriate anchor made for that material.

Set the wall support level along the line you just made. Be sure the beveled edge is facing up and outward from the wall (see diagram). Using a screwdriver or cordless drill to fasten the wall support to the studs, or appropriate anchor.

With the help of a second person, lift the completed FullTrap assembly up and gently rest the beveled cross support on the back of the Fulltrap down onto the beveled wall stretcher. The opposite beveled edges will lock together and safely support the FullTrap on the wall.

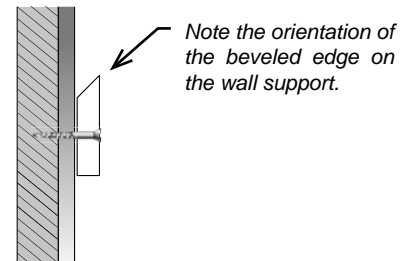
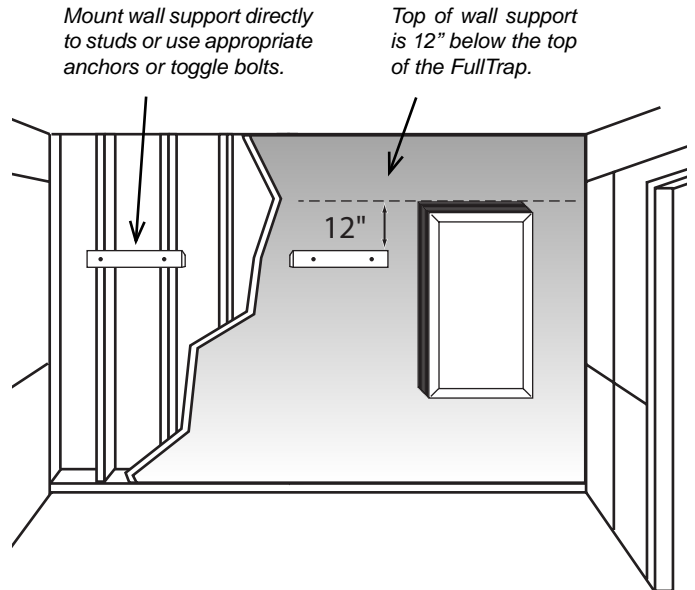

CORNER MOUNTING INSTRUCTIONS

The FullTrap may be mounted in 90 degree corners by using 45° Joist Hangers (not included with the FullTrap) available from your home center store or building supplier.

Measure and cut two pieces of 2" x 6" lumber in 17 inch lengths. Screw the hangers onto the ends of the 2 x 6 lumber with one inch wood screws. Mount the hanger and lumber assemblies in the corner using your bubble level and drywall anchors. Position the corner mounts so they will be hidden behind the FullTrap when installed. Use eight drywall anchors for each hanger and lumber assembly. Mount the beveled wall stretcher to the top 2 x 6 and hang the FullTrap the same way as for wall mounting.

