

ArtSound R8

Internet / DAB+ radio

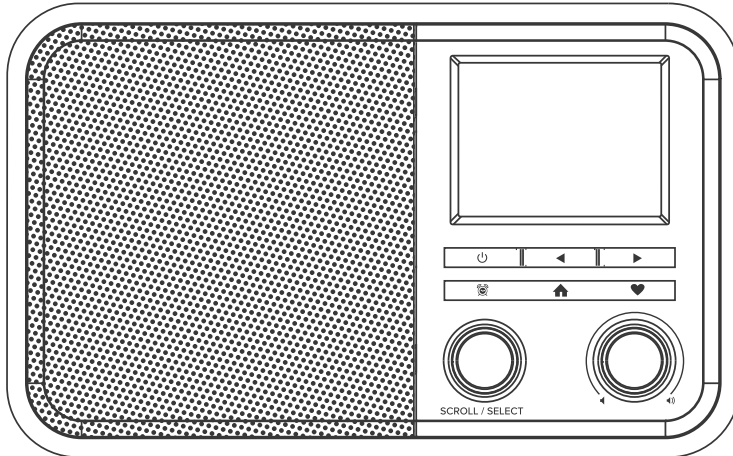

TABLE OF CONTENTS

1. Warnings and safety	2	16. Alarm Setting	10
2. Contents of the box	2	17. Sleep Timer Setting	10
3. Location of Controls	2	18. Configuration	10
4. Remote control	3	19. Remote control via PC / Smart phone Tuning internet radio & manage favourite	14
5. How to input password for your wireless network	4	20. Trouble Shooting	16
6. Before you start	4	21. Helpful Tips	17
7. Getting started	4	22. Technical Specification	18
8. Charging battery	5	23. Warranty conditions	19
9. Network Setup	5		
10. Overview of features and functions	6		
11. Internet Radio	6		
12. Media Centre	8		
13. DAB+/DAB Radio	8		
14. FM Radio	9		
15. Bluetooth playback	9		

Thank you for buying our ArtSound R8 radio. We hope you'll enjoy it for years to come. Please read these instructions carefully and keep this manual for later reference.

The R8 is a high-quality internet, DAB+ and FM radio with Bluetooth and a built-in rechargeable battery.

1. WARNINGS AND SAFETY

- To prevent fire or electric shocks, the device must not be exposed to rain or humidity.
- For your own safety: to prevent electric shocks do not remove the housing.
- Do not try to repair any malfunctioning parts of the device yourself. Ask a professional expert to do this for you.
- When plugged into the mains, the device remains electrically charged even when switched off.

2. CONTENTS OF THE BOX

- ArtSound R8 radio
- Remote control (without batteries)
- Power adaptor
- User manual

3. LOCATION OF CONTROLS

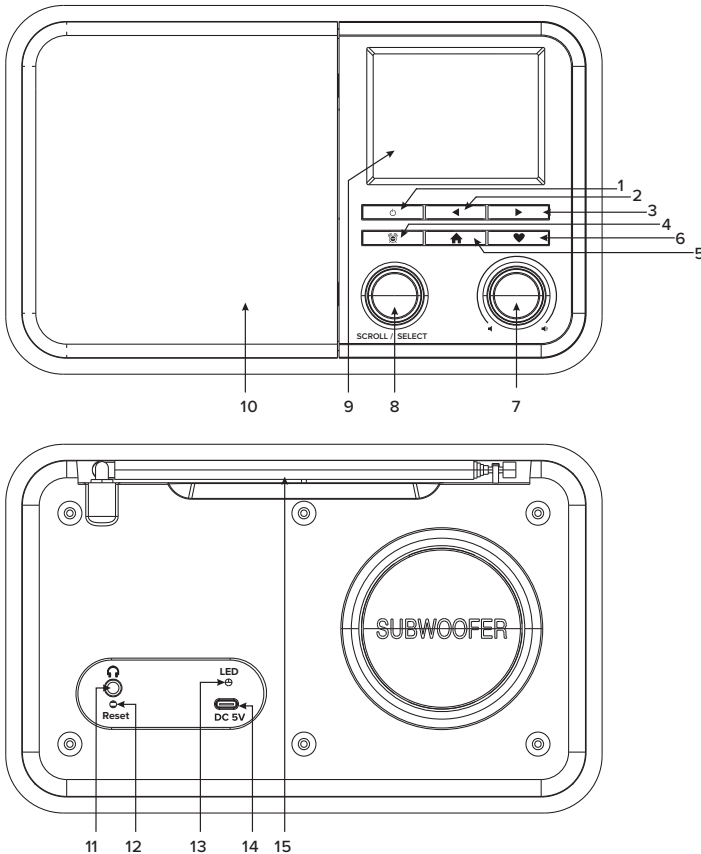

1. Press and hold to power on/off
Press and release to Standby / activate the radio
(Standby is enabled only when power is connected. It will be disabled when internal battery is used)
2. Back to previous menu/left cursor
3. Right cursor/Enter edit menu under Favourite list /View the big clock & radio info under playing screen
4. Press to enter the alarm setting (Alarm 1 and Alarm 2)
5. Access Home screen/press this button to return to the playing screen
6. Press and hold to preset a particular station
Press to recall the favourite list
7. Rotate to adjust the volume level
8. **Scroll / Select**
Rotate to scroll along, up/down on the menu Press in to confirm / Select menu options
Press in to stop / resume playback of radio channel
9. **TFT color screen 2.4"**
10. **Speaker**
11. **Earphone jack 3.5 mm**
12. **Reset pin hole**
13. **LED indicator for battery charging**
14. **DC IN Jack**
15. **Telescopic antenna**

4. REMOTE CONTROL

- Press to toggle between Standby and Operation (applicable only when Standby is enabled with power connected to the radio)
- Mute
- 0-9** Input index number on the list / input characters for WiFi password
- Preset the current playing station to Favorite
- Cursor up
- Cursor left / back to previous menu
- Alarm button
- Sleep Timer
- Mode** Switch between radio modes
- Home
- Previous station on the list/previous track on bluetooth/Media Centre
- Local** Access the local station list (Local area set up in Configuration)
- Recall the favorite list
- OK** confirm button
- Cursor right
- Cursor down
- Vol+** Volume up
- Vol-** Volume down
- EQ** Equalizer
- Next station on the list/next track on bluetooth/Media Centre
- Play/pause for Bluetooth/Media Centre Play/stop for Internet radio
- Dimmer** Access the Dimmer menu to adjust the brightness of the display
- Info** Quick access to Network and System information

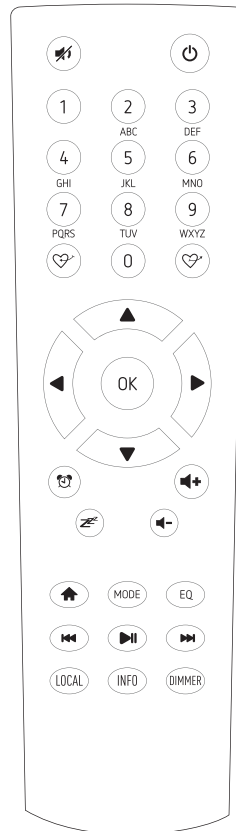

5. HOW TO INPUT PASSWORD FOR YOUR WIRELESS NETWORK

USING REMOTE CONTROL

On the alpha-numeric keypad, press the button repeatedly to cycle through the characters assigned to each button. Refer to the following list. To input a character, highlight it and press the **[OK]** button to confirm and input the next character. When it comes to the last character of the password, press and hold **[OK]** to complete the entry.

Button 1: 1 and different kind of symbols
!@#\$%^&*()_+[]{};:'" \,/ <> ?
Button 2: 2ABCabc
Button 3: 3DEFdef
Button 4: 4GHIghi
Button 5: 5JKLjkl

Button 6: 6MNOnno
Button 7: 7PQRSpqrs
Button 8: 8TUVtuv
Button 9: 9WXYZwxyz
Button 0: 0

USING CONTROL BUTTON ON THE RADIO UNIT

Use the **[Scroll/Select]** knob to scroll through the characters, highlight it and press **[Scroll/Select]** knob to confirm and input the next character. When it comes to the last character of the password, press and hold **[Scroll/Select]** knob to confirm and complete the entry.

Note: The password is case sensitive.

6. BEFORE YOU START

Please ensure the following is ready:

You have a broadband internet connection.

A wireless broadband router is connected to the internet successfully. The radio supports Wireless B, G and N connection (Wireless N router can also be used with the setting on B or G). You know the Wired Equivalent Privacy (WEP) or Wi-Fi Protected Access (WPA) data encryption code/password. You need to key in the correct code when the radio is connected to the wireless router for network connection. If you do not know the code/password, please contact the person/technician who set up the router/network for you.

The radio can work via Wireless network connection (Wi-Fi connection).

7. GETTING STARTED

The radio is powered by the built-in lithium battery. A USB cable and a power plug are supplied in the product package.

Press and hold the **[⏻]** button to power on.

To power off the radio, press and hold the same button.

The Standby mode is enabled only when the power is connected and so to make use of the Alarm clock function.

Connect the power supply to the radio, press and hold the **[⏻]** button to turn it on. Pressing the **[⏻]** button again will put the radio into standby.

8. CHARGING BATTERY

You can check the level of battery power remains on the radio. There is a battery power indicator  showing on the top row of the screen. When battery power is low, the battery indicator keeps blinking as a reminder for battery charging. To charge the battery, connect the micro USB plug to the port where located at the rear side of the radio, connect the other end to a power source supplied in 5V OUT, or connect the USB cable to the power plug supplied in the package and plug in to the electric outlet. The LED will light up in red indicates the battery is charging. The LED will turn to green when charging is done.

Note: The charging might take much longer to complete if the radio is playing while charging.

9. NETWORK SETUP

Internet connection can be setup via Wireless network (WiFi). Your radio requires a broadband Internet connection.

- If this is first time use, the Configure Network wizard will be displayed. Choose Yes to start configuring network. Press the [◀] button to highlight Yes and press [Scroll/Select] to confirm.

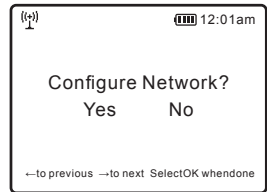

- Select Add/Remove AP from the list, use the [Scroll/Select] knob to scroll and press it to confirm, then choose Add AP (Scan):

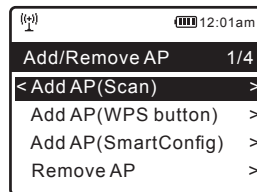
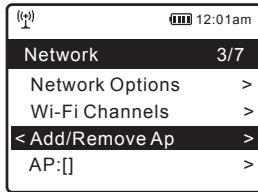

- It will start scanning the Wi-Fi networks available. Scroll to your network and press [Scroll/Select] to confirm. If your wifi network has a password protected, it will ask you to enter the passphrase/password. Please refer to the above section '**How to input password for your wireless network**' on P.3.



Note: The password is case sensitive. Please consult with the one who setup your network if you don't know the password.

- When the Wi-Fi connection is successful, the Association Complete will be shown briefly. The wifi signal bar will appear on the top left corner of the display

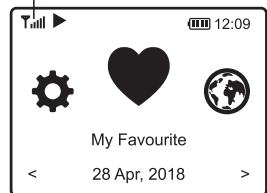
Wi-Fi signal bar



10. OVERVIEW OF FEATURES AND FUNCTIONS

Press [] to enter the main menu. Scroll by rotating the [Scroll/Select] knob or the [ / ] button on remote:

My Favorite To show the list of favorite stations which have been assigned to the presets. There are up to 99 presets available.

Internet Radio Start exploring the worldwide radio stations and music here.

Media Centre You can browse and stream music from your network via UPnP or DLNA Compatible devices.

DAB+/DAB Radio

Pick up DAB+ and DAB radio signal if available in your local area (no internet connection required).

FM Radio Receive ordinary FM radio stations in your local area (no internet connection required).

BT Streaming Bluetooth playback, to play audio stream (receive) from another Bluetooth enabled device after pairing/connected each other.

Alarm Alarm clock. Two alarm settings available (works only when power is connected).

Sleep Timer Enable the timer to turn the radio in standby after the selected time elapsed.

Configuration More options/settings available to personalize as you desire.

11. INTERNET RADIO

On the main menu, choose **Internet Radio** and you will find the options below:

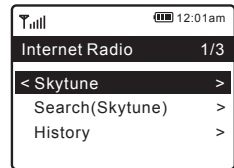

SKYTUNE

Select Skytune to start enjoying thousands of radio stations over the world. You can filter your search by Region, Music genre and talks.

The **Local Radio** let you access quickly the stations available in your local area through internet connection.

Note - You can change the Local Radio area under Configuration> **Local radio setup**. Please refer to section 12 for the details.

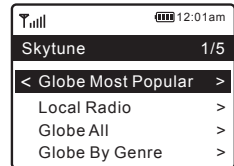

When you scroll along the list of **Globe All** and want to quickly reach to a certain point of the long list, input the index number on the remote control to quickly jump to that point. For example, on the remote control, input 2 8 and press OK, it will highlight the station no. 28.

SEARCH

Instead of browsing the radio station list, you can input a few characters of the desired station to filter out / short list the stations.

HISTORY

The radio memorizes the stations you have listened up to 99 stations.

If you have listened more than 99 stations, it will supersede the first station that you have listened.

START PLAYING INTERNET RADIO

When a radio station starts playing, more radio information can be displayed. Press the ► button in the state of the playing screen below:



Every time you press the ► button, it will toggle between the big clock and the radio channel information:

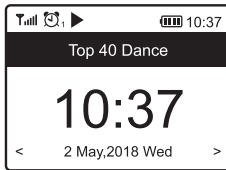
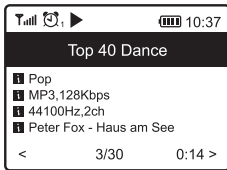

MY FAVORITE

This is to show the list of your Favorite stations which have been assigned to the presets.

PRESET A STATION

When a radio station is playing, press the ♥ button on the remote control or press and hold the ♥ on the unit, you will see the ▽ icon appears as below. It means the station is added to the Favorite list.

Preset icon

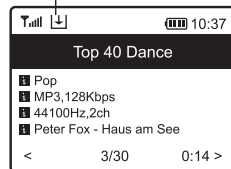

The new added station will always show in the last item on the Favorite list. You can store up to 150 presets.

RECALL A STATION

Press the ♥ button on the remote control or press the ♥ briefly on the radio unit to recall the list of presets, or navigate to **My Favourite** on the main menu and select it to confirm.

EDIT YOUR FAVORITE LIST

On the Favorite list, choose the radio station you want to edit then press the [►] button on the remote control (or press [►] on the unit). It will enter the Edit menu with the following options:

- Move down** To move down the ranking of a station
- Move up** To move up the ranking of a station
- Delete** To delete a particular station
- Move to top** To move the station to the top of the favorite list.
- Move to bottom** To move the station to the bottom of the favorite list.

12. MEDIA CENTRE

The device supports UPnP and is DLNA-compatible.

This provides the opportunity to stream music from your network. However, this requires you to have a compatible device in your network that can function as a server. This can be e.g., a network hard drive or a conventional PC with e.g., Windows 8 via which access to the shared folder or media sharing is permitted. The folders can then be browsed and played on the radio.

Note – Please make sure your computer laptop is on the same Wi-Fi network as the Radio before you start using this function.

MUSIC STREAMING

- Once the UPnP/DLNA compatible server is configured to share media files with your radio, you can start music streaming.
- On the main menu, select **Media Centre and choose UPnP**.
- It may take a few seconds for the radio to complete the scan for available UPnP servers. If no UPnP servers are found, it will show **Empty List**.
- After a successful scan is done, select your UPnP server.
- The radio will show the media categories available from the UPnP server, e.g. 'Music', 'Playlists' etc.
- Choose the media files that you wish to play.
You can set the mode of playback under **Configuration > Playback setup**.

MY PLAYLIST

You can make your own playlist for the UPnP music files. Choose and highlight the song you want to add to playlist, press and hold the **[Scroll/Select]** knob or press and hold the **[OK]** button on remote, until the sign  appears. The song will be added to **My playlist**.

CLEAR MY PLAYLIST

Remove all songs in “My Playlist” to allow a new playlist to be prepared.

Note – If you have DLNA compatible servers available, follow the steps described above to browse the audio files from DLNA compatible device on the radio to play.

13. DAB+/DAB RADIO

If there is Digital Audio Broadcasting (DAB) in your area, the Radio can pick up the DAB stations as well (no internet connection is required). The Radio supports both DAB and DAB+.

Place the Radio close to the window and extend the antenna as far as it can go to get the best reception. Sometimes you may need to adjust the direction of the antenna to improve reception.

On the Home screen, scroll to **DAB Radio** or use the **[Mode]** button on remote to switch to DAB Radio. Press **[OK]** to start.

It will ask whether you want to **Scan DAB Station**. Press **[Scroll/Select]** knob (or **OK** button on remote) to start scanning and it will show the progress on the number of channels received. When it is done, a preset page will be displayed for your action.

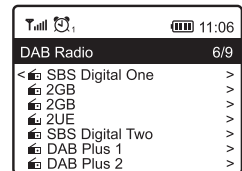

You can select the channel and start listening to it. Whenever you want to add to My Favourite, press the  button on remote or press and hold the **♥** button on the radio, and it will add to the favourite list.

Always press the **[◀]** button to return to the Preset list.

Note – When a DAB radio is playing, press the [▶] button to view more radio information, each time you press the [▶] button, it will display various information at a time such as radio frequency, rolling texts (if available) and big time clock.

New digital radio stations should be picked up automatically by the radio if they are part of a multiplex you already received. Otherwise you need to do the Preset Scan again.

14. FM RADIO

To receive the ordinary FM stations (no internet connection is required), place the radio close to the window and extend the antenna as far as it can go to get the best reception. You may need to adjust the direction of the antenna to improve reception.

On the Home screen, scroll to FM Radio or use the [Mode] button on remote to switch to FM Radio. Press [Scroll/Select] knob (or OK button on remote) to start.

It will ask whether you want to Scan FM Station. Confirm to start scanning and it will show the progress on the number of channels are found. When it is done, it will automatically save the found channels on presets and display the list for your action.

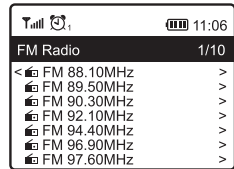

You can select the channel and start listening to it. Whenever you want to add to **My Favourite**, press the ♥ button on remote or press and hold the ♥ button on the radio, and it will add to the favourite list.

Always press the [◀] button to return to the Preset list.

Note – When it is playing FM radio, press the [▶] button to view more radio information, each time you press the [▶] button, it will display various information at a time such as radio frequency and big clock display.

MANUAL TUNE

To manual tune to the frequency, press and hold the [OK] on remote or press and hold [Scroll/Select] on the radio, until you see the "Tuning" appeared on the display, at the bottom right corner. Use the [Scroll/Select]

knob (or [◀ / ▶] button on remote) to tune the frequency. When done, press and hold the [Scroll/Select] knob (or press and hold the [OK] button on remote) to exit manual tune.

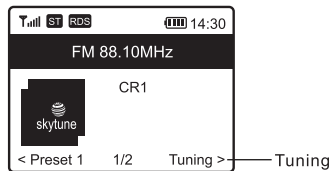

15. BLUETOOTH PLAYBACK

Before transmission between your Bluetooth device and the radio is possible, both devices must be coupled. This process is called "pairing". The radio is served as a receiver, to receive music stream to play on the radio.

If you have already coupled to a Bluetooth device before, this connection will be restored automatically when both devices are in range and Bluetooth operation has been selected on the radio. "Pairing" does not have to be repeated. This function may need to be activated in your Bluetooth device, however.



- Push the Menu button to display the selection menu for the different operating modes.

- Use the up/down button to select the operating mode Bluetooth and push the dial switch.
- Switch your Bluetooth device to which you want to connect the radio on and activate the pairing mode here. The device scans for Bluetooth devices in the reception range.
- When the radio is found, your bluetooth device shows its name ArtSoundR8-XXXX (the XXXX is an identification code for your radio unit).
- Select the radio at your bluetooth device.
- Start playback on your bluetooth device.
- Playback now takes place using the radio.

16. ALARM SETTING

Important!

To use the Alarm clock function, please have the radio connected with a power supply so to have the Standby mode enabled. When the radio is turned on, press and release the [] button to put the radio into standby. Standby is disabled when the radio is using internal battery.

- Press [] button on the radio or press the [] button on the remote control.
- Select either Alarm 1 or Alarm 2, choose **Turn on** to activate the Alarm.
- Follow the alarm wizard instructions to set the alarm.
- The wizard will guide you through the settings below:

Time	Set the time for the alarm
Sound	You can choose Wake to Tone, My Favourite, Wake to FM Radio or Wake to DAB Radio as the alarm source. Note : Wake to FM or Wake to DAB Radio - only the preset stations can be used for the radio alarm (if the preset scan has been completed). Wake to My Favourite: Please preset your favorite station before setting this as the alarm source.
Repeat	You can schedule the alarm as you desire -Everyday, Once or multiple days.
Alarm Volume	Adjust the volume of the alarm as you like by rotating the [Scroll/Select] knob or [] button on remote.
Alarm duration	Set the duration of the alarm from the preset options ranging from 30 to 180 minutes. The radio will be turned to standby when the selected duration of time is due.

- After the above settings are completed, press the [] button to exit and make sure the Alarm is turned on. You will see the Alarm icon appeared on the display if it is activated.

STOPPING THE ALARM/ACTIVATE THE SNOOZE FUNCTION

When the alarm goes off, press the [] to stop the alarm or press the [**Scroll/Select**] knob to activate the Snooze feature.

When the Snooze is activated, the alarm is muted for 9 minutes and sounds again when the time is due. You can repeat the process multiple times.

To stop the "Snooze" function, press the [] .

17. SLEEP TIMER SETTING

You can set the timer to let the radio goes standby after the selected time elapsed in the range of 15 minutes to 180 minutes.

Press [] button on the remote control to set the timer, or navigate to Sleep Timer option on the main menu.

You will see the icon appeared on the display if the timer is set.

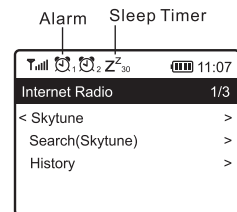

18. CONFIGURATION

Here you will find the complete settings / options available to configure your own radio. On the main menu, navigate to Configuration setting. Press OK and you will see a list of options available.

NETWORK

Network Options

Always on: The WLAN function remains switched on (faster access when switching from other modes of radio).

Auto off in 30s: The WLAN function shuts down after 30 seconds when not in use (to save energy).

Wi-Fi Network

• Add / Remove AP

Add AP – It will scan out a list of routers around.

Add AP (WPS button) – Choose this option to connect your Wi-Fi router via WPS if the router has a WPS button.

Remove AP – If you have already added a router and want to remove it, choose this option.

Note – Always place the radio within 2 meters of the Wi-Fi router for setup.

• AP: []

If you have added more than one routers on the radio and want to switch to another one, select this option to change.

• Signal

This is to show the strength of the Wi-Fi Signal of the Wi-Fi router as received by the radio. Usually signal levels lower than -70dBm is at weaker level and if it affects the reception of your radio, you may need to optimize the router location or check any problem of the router itself.

• IP

The IP is set Dynamic by default. Select to change Fixed IP according to your network condition.

• DNS

The DNS is set Dynamic by default. Select to change <Fixed> DNS according to your network condition.

WI-FI CHANNELS

Not all of the Wi-Fi channels are available in every country. There may be variation between different countries. Therefore it is necessary to choose the Wi-Fi channels to ensure the Wi-Fi performs satisfactory.

We have already set the channels according to the requirement in different countries. Choose the country you are staying from the list to get the correct channel.

DATE AND TIME

The radio will set your local time automatically after the internet connection is completed. If you want to do manual setting, change it by the following options:

• Time zone

Auto-set Time Zone: This option is set by default.

Manual-set Time Zone: Choose this option if you want to set the time in another region. Choose and highlight the region/city you prefer and press OK to confirm.

Coupled with NTP (use network time) and DST (Daylight time saving) will be adjusted automatically if you choose to use network time (NTP).

• Set Time Format

Choose either 12-hour or 24-hour notation you prefer.

• Set Date Format

• DST (Day Light Saving)

Enable on/off

• NTP (Use network time)

NTP is designed to synchronize a device's clock with a time server. Your radio will synchronize the time server by default every time it powers up and connects to Internet. This ensures a very high degree of accuracy in the radio's clock. You can change to use other time server by inputting the URL address (see below NTP server). You can choose "Do not use network time" if you don't want it to.

If you choose not to use NTP for clock synchronization, highlight the NTP (Network time protocol) and press OK to make the change. You will see the Set Date & Time appeared on the menu. Select it and adjust the date and time as you desire.

- **NTP Server**

NTP is designed to synchronize a device's clock with a time server. Here it shows the server being used for the radio.

LANGUAGE

The default language is English, you can choose other languages as preferred. Scroll with the ▲▼ buttons on remote or [Scroll/Select] knob to the item with  and press **OK**. Scroll to highlight and press **OK** to select your language of choice. English, French, Spanish, Italian, German, Dutch, Polish, Russian and more are available.

LOCAL RADIO

The radio is set by default to detect the radio stations in your local area automatically through internet connection and these stations can be accessed by a press of [Local] button on remote. You can also set Local in another region if you want. Highlight the Local Radio and press **OK**. Choose **Manual-set Local** radio to change the region setting.

DAB SET UP

- **DAB Preset Scan**

You can always carry out a new scanning of DAB channels by selecting this option. All current presets and channels will be erased.

- **DAB Radio Preset**

The scanned DAB stations will be listed here for management. You can move the position or even delete any station. Scroll to the station and press [▶] button. A pop up window will be presented: Move up, Move down and Delete.

FM SETUP

- **FM Area**

Choose the Region according to your physical location to define the search range for the radio.

- **FM Preset Scan**

You can always carry out a new scanning of FM channels by selecting this option. All current presets and channels will be erased.

The radio at the lowest frequency of the scanned values will be highlighted. The preset list will be saved unless a new preset scan is carried out.

- **FM Radio Presets**

You can adjust the preset ranking by Move down, Move up or Delete it. Highlight one of the preset, then press the [▶] button, it will enter into the Edit menu. Always press the [◀] button to return to the Preset list.

PLAYBACK SETUP

This is to set the mode of playback under UPnP/DLNA compatible streaming: Repeat All, Repeat Once or Shuffle.

RESUME PLAY OPTIONS

This is to set the device whether to return to the last operating mode when it is switched on or displays the Home screen.

DIMMER

You can set the backlight level for the display as you prefer. There are two settings: Mode and Level

- **Mode – Normal or Power Saving**

Normal – the display will stay with the same level of brightness all the time without dim down.

Dim – the display will dim down after 20 seconds if no operation is made on the radio.

- **Level – Bright and Dim**

Bright – This is to adjust the level of brightness in Normal mode. Dim – This is to adjust the level of brightness in Dim mode.

- **Dimmer in Standby (Standby is only enabled when power is connected)**

The display brightness in standby mode can be adjusted manually by turning the rotary knob [Scroll/Select] or press the ▼ ▲ buttons on remote. If no action taken in 20 seconds, it will restore to the dim value as set in Configuration.

EQ (EQUALISER)

Various music genres can be set.

BUFFER TIME

Sometimes you may experience uneven playback of the internet radio. This can happen if the internet connection is slow or network congestion occurs. To help improving the situation, you can choose longer buffer time to get a few seconds of radio stream before beginning to play.

The default value is 2 seconds. You can choose 5 seconds if you prefer to have a longer buffering time.

INFORMATION

View the Network and System Information of your radio.

To access quickly to this information, press the [Info] button on the remote control.

When you use your PC to manage the My favorite stations, you have to use the IP address and you can view this info from here. Then type in the IP address (Configuration > Info > Network > IP) to your PC's browser input window.

SOFTWARE UPDATE

There may be a software update to upgrade features of the radio from time to time.

RESET TO DEFAULT

You can do the reset to clear all the settings and return to default settings.

** Please note all the Station presets, Settings and configuration will be erased after you have performed the Reset.

19. REMOTE CONTROL VIA PC / SMART PHONE - TUNING INTERNET RADIO & MANAGE FAVOURITE

Experience an easy way to control tuning internet radio channels and manage your favourite list via PC or Smart phone's web browser. The supported browsers are Internet Explorer and Chrome.

- Connect your PC or Smart phone to the same Wi-Fi network as your radio.
- Visit www.skytune.net
- On the home page, click "Browse/Search"
- Browse or enter the name to search the radio channel, a list of internet radio channels will be displayed.
- Click the "♥" symbol

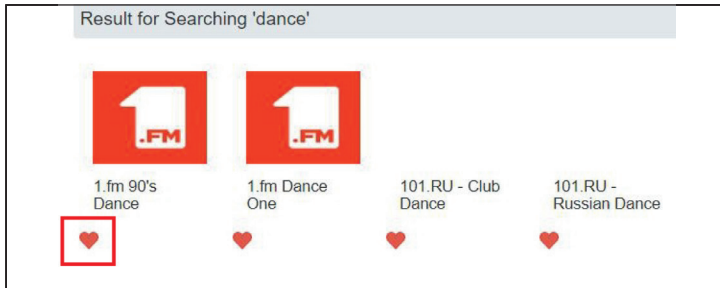
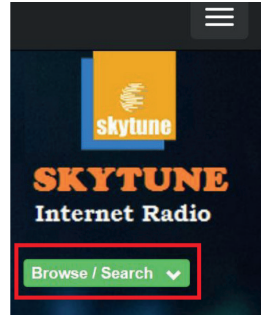

- It will prompt you whether to "Add Favourite" or "Listen to Station". Enter the IP address of your radio (e.g. 192.168.1.11):

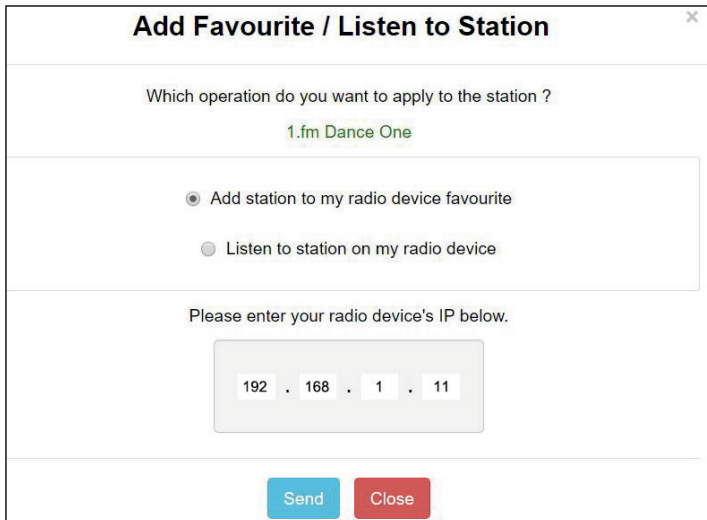

The IP address can be located on the radio unit as follow:

- On the remote control, press the [Info] button, choose Network and scroll to IP to view the IP address
- On the radio, return to the main menu. Navigate to **Configuration > Information > Network Information > IP**

Select "Listen to Station", click "Send" and the radio unit will switch playing the channel and the "My Favourite" page will pop up on the web browser.

You can then choose to add the playing station to favourite or manage your list by other edit options. Any changes will synchronize to the radio unit immediately.



You can also add the radio channel if you know the published audio stream URL with the streaming format as follow:

1. Transport: HTTP progressive like HLS and HTTP like Shoutcast, Icecast
2. Audio: MP3, AAC, AAC+, FLAC
3. Playlist: M3U, PLS

20. TROUBLE SHOOTING

Problem	Cause	Solutions
Cannot connect to Wi-Fi network	Network down	<ul style="list-style-type: none"> • Confirm that a Wi-Fi or Ethernet Wired connected PC can access the internet (i.e. can browse the web) using the same network. • Check that a DHCP server is available, or that you have configured a static IP address on the radio. • Check that you firewall is not blocking any outgoing ports. As a minimum the radio needs access to UDP and TCP ports 80,443 and 8008, DNS port 53.
	Router restricts access to listed MAC addresses	<p>Obtain the MAC address from Configuration > Information > Network > Wi-Fi MAC and add to the allowed equipment list on your access point.</p> <p>Note: The radio has separate MAC addresses for wired and wireless networks.</p>
	Insufficient Wi-Fi signal strength	<ul style="list-style-type: none"> • Check distance to router; see if a computer can connect to the network in this location • Optimize the distance of the router's location
	Unknown encryption method	Change encryption method on router. The radio supports WEP, WPA, WPA2
	Firewall preventing access	Windows Media Player: varies — non-Microsoft firewalls may require configuration for UPnP.
If your radio can connect to the network successfully, but is unable to play particular stations		<ul style="list-style-type: none"> • The station is not broadcasting at this time of the day (remember it may be located in a different time zone). • The station has too many people trying to attach to the radio station server and the server capacity is not large enough. • The station has reached the maximum allowed number of simultaneous listeners. • The link on the radio is out of date. The update of the link is done regularly. To get the updated list of stations, please access from Internet radio > Skytune. In case a particular stream is still not working, please contact us or report the case to Skytune.
No DAB/FM reception		<ul style="list-style-type: none"> • Please carry out "Factory Reset" on the radio and extend the antenna. • Move the radio close to the window.
DAB/FM radio reception is poor		<ul style="list-style-type: none"> • Please check that the aerial is extended for the maximum signal strength and adjust the direction to improve reception. • Check that you do not have other electrical equipment too close to your radio, causing interference.

No sound		<ul style="list-style-type: none"> • Please check if the volume is muted. Tune up the volume and see. • If that happens on a particular internet radio station, please try other channels and see if this is isolated issue on that station.
Radio got freeze or no response		Insert a small paper clip in the reset pinhole and hold the button down, the radio will switch off. Try turning the radio on again.

21. HELPFUL TIPS

1 If the Internet Radio keeps re-buffering radio station:

The Internet Radio is streaming the data from the radio station via your broadband connection, if there is a high error rate on your broadband connection, or the connection is intermittent, then it will cause the Internet Radio to pause until the connection is re-established and it has received enough data to start playing again. If your Internet Radio keeps stopping, please check the DSL modem to ensure that the Broadband line is not suffering a high error rate or disconnections. If you are experiencing these problems, you will need to contact your broadband supplier.

2. What is Buffering?

When playing a stream, the Internet Radio/Media player, downloads a small amount of the stream before it starts playing. This is used to fill in any gaps in the stream that may occur if the internet or the wireless network is busy.

The Internet Radio streams music data from the PC while you are listening. If a stream gets blocked or experiences Internet congestion while transferring it may stop/interfere with the quality of play. If this happens, check your internet connection speed- it must be faster than the speed of the streams.

3. My radio is working but some stations cannot be played.

The problem may be due to one or more of the followings:

- a. The radio station is no longer broadcasting.
- b. The radio station has reached the maximum allowed number of simultaneous listeners.
- c. The radio station has changed the stream arrangement and the link is no longer valid.
- d. The radio station is not broadcasting at the time of the day (not all stations are broadcasting 24 hours throughout the day).
- e. The Internet connection between your radio and the radio station server is too slow or unstable to support the data rate of the broadcast.

22. TECHNICAL SPECIFICATION

description	internet – DAB+ - FM - bluetooth radio
radio	internet radio (auto update) FM (RDS) / DAB+
memory	99 programmable radio stations
functions	search by genre, location or your favourites alarm / clock / sleep timer / internet clock sync (NTP) equalizer subwoofer
antenna	telescopic
Bluetooth	Yes (V4.2 BR/EDR 2.4 GHz)
internet connection	WLAN -802.11b/g/n uPnP & DLNA support
control	remote control
output	headphone jack
power supply	USB-C (DC 5V)
battery	2200mAh (4 h) – Lithium - Ion
dimensions (h x w x d)	115 x 186 x 110 mm
weight / piece	0,89kg
composition	wood / ABS plastic
colour	black

Remark: Specification may vary without notice

23. WARRANTY CONDITIONS

2 year warranty from date of purchase. The warranty is limited to the repair or replacement of the defective material insofar as this defect is a result of normal use and the device has not been damaged. Artsound is not responsible for any other costs that ensue as a result of the defect (e.g. transport). For details, please consult our general terms and conditions of sale.



This product bears the selective sorting symbol for waste electrical and electronic equipment (WEEE). This means that this product must be handled pursuant to European Directive 2002/96/EC in order to be recycled or dismantled to minimize its impact on the environment. For further information, please contact your local or regional authorities.



I, House Of Music NV, hereby declare that the type of radio equipment ARTSOUND complies with Directive 2014/53/EU. The full text of the EU Declaration of Conformity can be found at the following internet address: <http://www.artsound.be/en/support/downloads>

Disclaimer: All trademarks are the property of their respective owners. All specifications and information are subject to change without further notice. Slight variations and differences might appear between printed photos and actual product due to product enhancement.

House Of Music NV - Legen Heirweg 23D, 9890 Gavere - Belgium

artsound

we speak sound

House of Music nv, Legen Heirweg 23D, B-9890 Gavere
© www.artsound.be @ artsoundaudio f artsound.audio

artsound
we speak sound