



WORK
PRO

ARENA SERIES (IP54)

ARENA 6CX

ARENA 8CX

ARENA 10CX

ARENA 12CX

ARENA 28S v.1.1

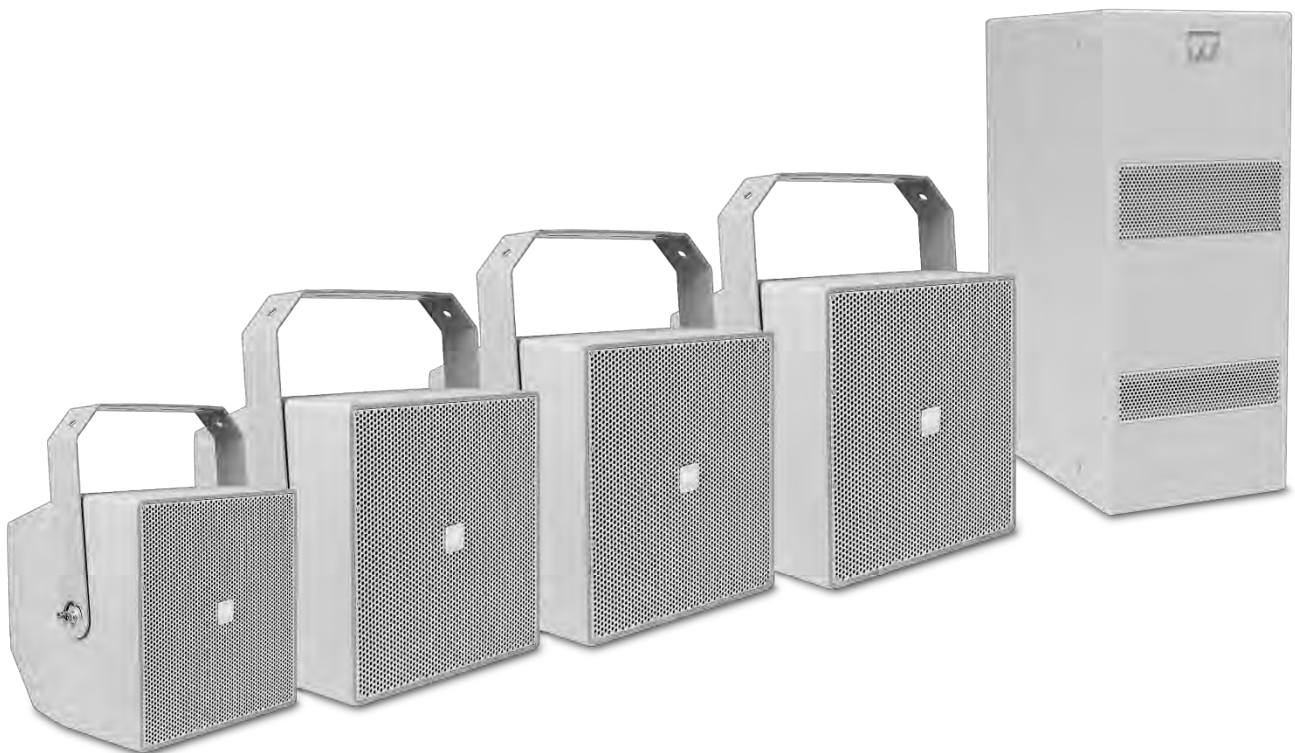

OVERVIEW

The **ARENA Series** compact coaxial loudspeaker system is designed to provide high quality sound reproduction in applications requiring extreme weather resistance. All cabinets are built from water-resistant polyvinyl board with tough texture coating. The hydrofobically-treated grill, moisture-sealed crossover and waterproof connector makes it reliable under long-term exposure to tough environmental conditions.

The **ARENA Series** consists of full range 6"/8"/10"/12" coaxial speakers and a dual 8" subwoofer.

Ideal for stadiums fairgrounds, outdoor entertainment centers, athletic fields, swimming pools background music, worships, multipurpose outdoor and indoor venues, etc.

Technical Data:

	ARENA 6CX	ARENA 8CX	ARENA 10CX	ARENA 12CX	ARENA 28S
Power (Passive)	300W	360W	400W	600W	700W
Impedance	8Ω Nominal				4Ω Nominal
70V	60W/30W/15W/7.5W	120W/60W/30W/15W	200W/100W/50W/25W	-	-
100V	60W/30W/15W	120W/60W/30W	200W/100W/50W	-	-
Transducer	LF: 1 x 6.5", HF: 1" Compression driver (Coaxial)	LF: 1 x 8", HF: 1" Compression driver (Coaxial)	LF: 1 x 10", HF: 1-3/8" Compression driver (Coaxial)	LF: 1 x 12", HF: 1-3/4" Compression driver (Coaxial)	LF: 2 x 8" band-pass
Connectors	Waterproof 4 pin connection system				2 x 4 Pin XLN Speakon
Frequency response	80Hz – 20KHz	80Hz – 20KHz	70Hz – 20KHz	65Hz – 20KHz	45Hz – 200Hz
Sensitivity	97dB	100dB	105dB	107dB	95dB
SPL Max	125dB	128dB	133dB	135dB	125dB
Dispersion	110° x 110° (-10dB)	110° x 110° (-10dB)	95° x 95° (-10dB)	60° x 60° (-10dB)	Omnidirectional
Cabinet construction	Water-resistant polyvinyl				
Mounting	U Bracket				Metal stand mount on top
Finish	Texture coating				
Grill	Aluminium with hydrofobically treated				
Measures W/H/D	256mm 275mm 251mm	299mm 310mm 299mm	330mm 370mm 330mm	409mm 450mm 409mm	208mm 450mm 670mm
Weight	9.2Kg	11.5Kg	15.3Kg	19,5Kg	22.8Kg

FEATURES:

- Customized high performance woofer & compression driver.
- Built-in 70V/100V transformer with power tap switch (ARENA 6CX, 8CX & 10CX).
- Made of water resistant polyvinyl. IP54.
- Hidrophobically-treated Grill.
- Waterproof strip connector.
- U-bracket included for installation (ARENA 6CX, 8CX, 10CX & 12CX).

CONNECTIONS

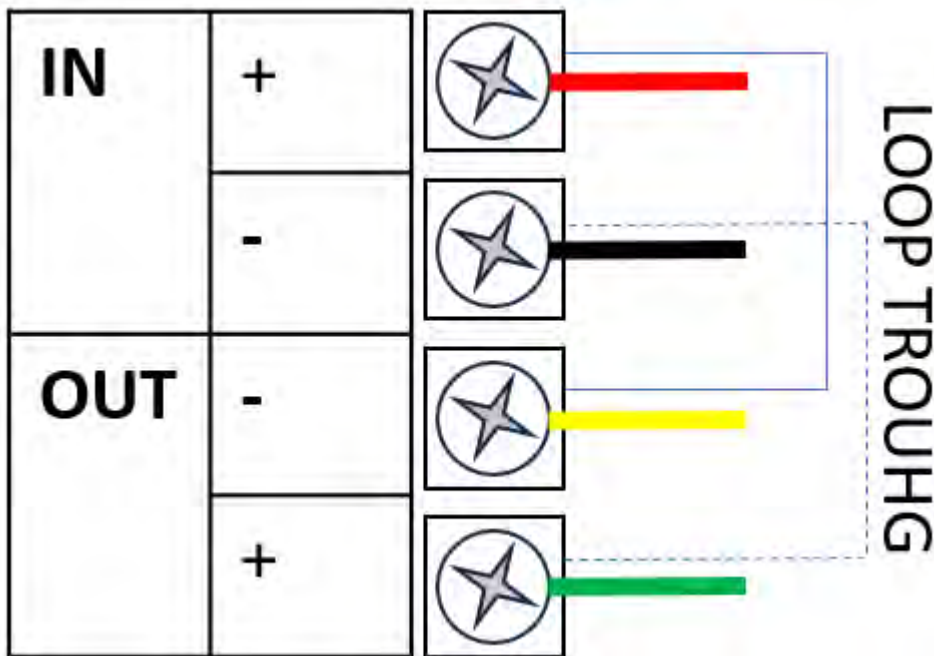

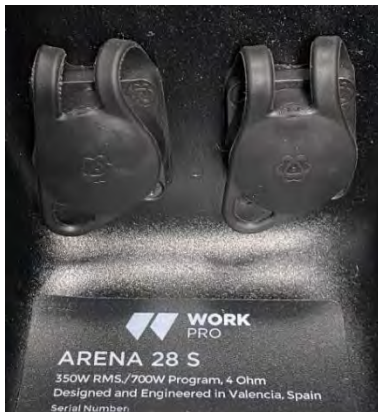

INSTALLATION

CAUTIONS

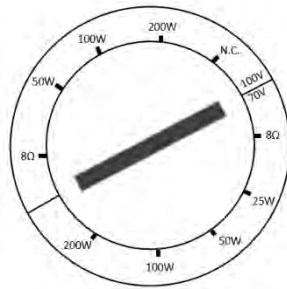

To connect to a 70/100V line speaker, select the desired power corresponding to its power, to connect to a low impedance speaker, select 8Ω.

MEASURES (mm):

ARENA 6CX

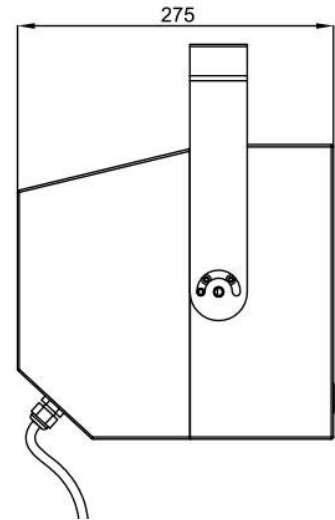
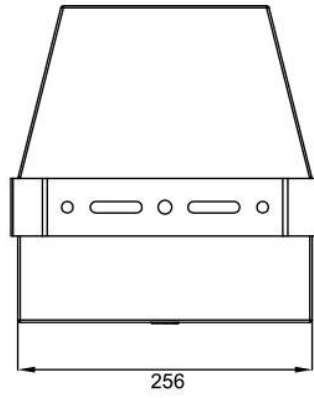
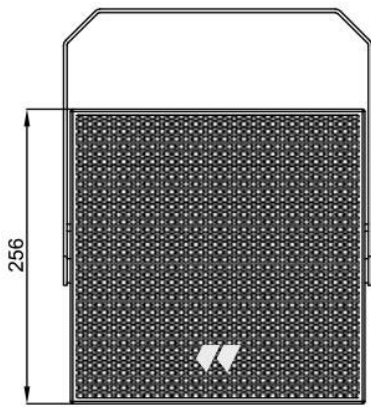

ARENA 8CX

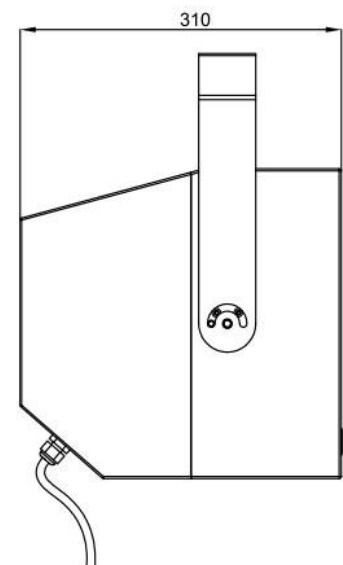
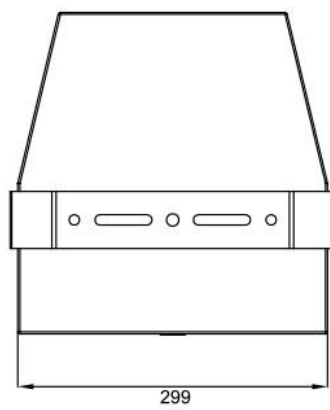
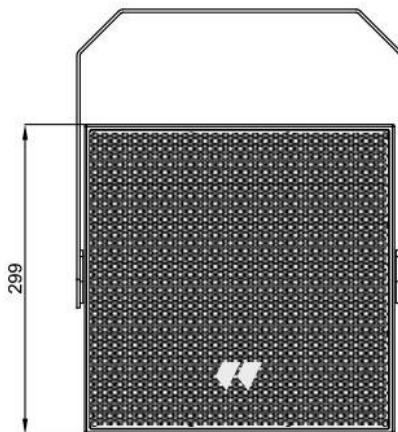

ARENA 10CX

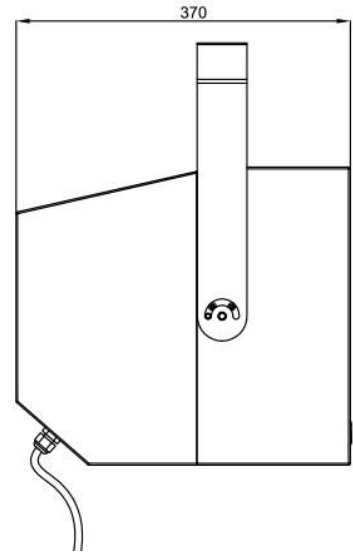
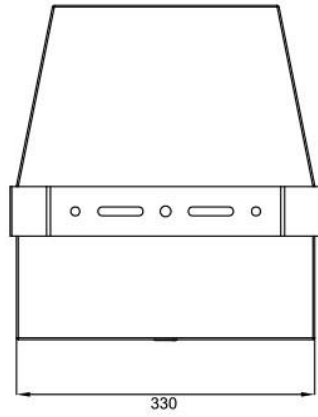
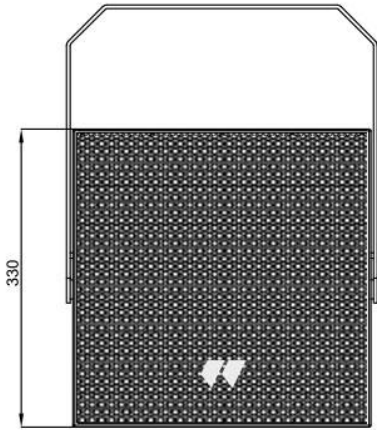

ARENA 12CX

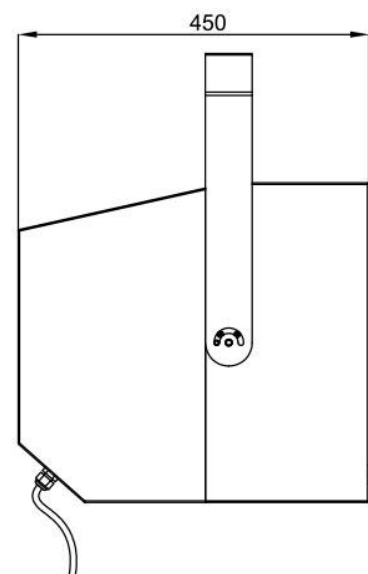
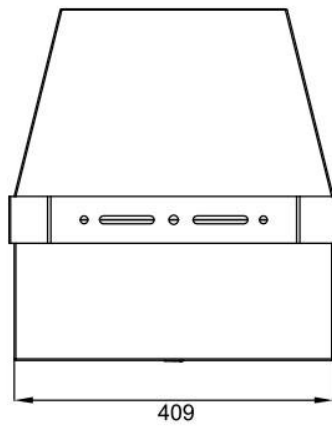
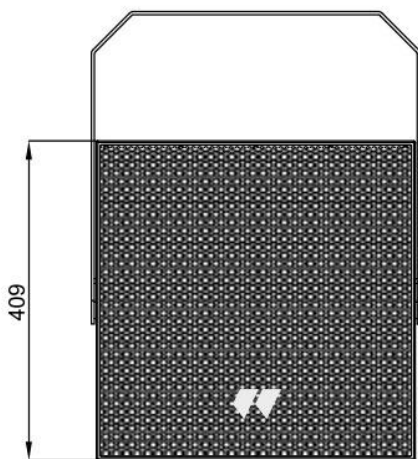

ARENA 28S

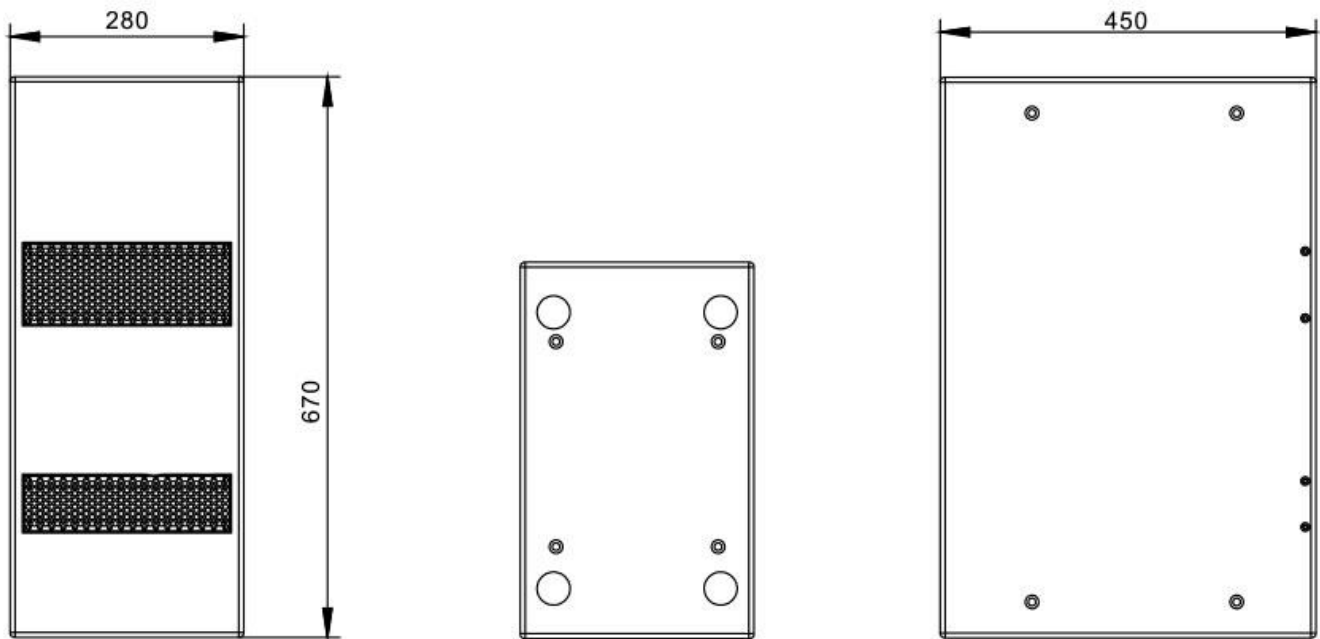

DESCRIPCIÓN GENERAL

La **Serie ARENA** de altavoces coaxiales compactos está diseñada para proporcionar una reproducción de sonido de alta calidad en aplicaciones que requieren una resistencia extrema a la intemperie. Todos los recintos están fabricados con tablero de polivinilo resistente al agua con un revestimiento de textura de alta calidad. La rejilla tratada hidrófobamente, el crossover sellado contra la humedad y el conector impermeable hacen que sea fiable bajo una exposición prolongada a duras condiciones ambientales.

La **Serie ARENA** consta de altavoces coaxiales de rango completo de 6"/8"/10"/12" y un subwoofer doble de 8".

Ideal para estadios, recintos feriales, centros de ocio al aire libre, campos de atletismo, piscinas, música de fondo, lugares de culto, espacios polivalentes de interior y exterior, etc.

Datos Técnicos:

	ARENA 6CX	ARENA 8CX	ARENA 10CX	ARENA 12CX	ARENA 28S

Potencia (Pasiva)	300W	360W	400W	600W	700W
Impedancia	8Ω Nominal				4Ω Nominal
70V	60W/30W/15W/7.5W	120W/60W/30W/15W	200W/100W/50W/25W	-	-
100V	60W/30W/15W	120W/60W/30W	200W/100W/50W	-	-
Transductor	LF: 1 x 6.5", HF: 1" Compresión driver (Coaxial)	LF: 1 x 8", HF: 1" Compresión driver (Coaxial)	LF: 1 x 10", HF: 1- Compresión driver (Coaxial)	LF: 1 x 12", HF: 1-3/4" Compresión driver (Coaxial)	LF: 2 x 8" Pasa Banda
Conexionado	Sistema de conexión impermeable de 4 pines				2 x 4 Pin XLN Speakon
R. en Frec.	80Hz – 20KHz	80Hz – 20KHz	70Hz – 20KHz	65Hz – 20KHz	45Hz – 200KHz
Sensibilidad	97dB	100dB	105dB	107dB	95dB
SPL Max	125dB	128dB	133dB	135dB	125dB
Dispersión	110° x 110° (-10dB)	110° x 110° (-10dB)	95° x 95° (-10dB)	60° x 60° (-10dB)	Omnidireccional
Construcción	Polivinilo resistente al agua				
Montaje	Soporte a pared en U				Soporte metálico superior
Acabado	Revestimiento texturizado				
Rejilla	Aluminio con tratamiento hidrofóbico				
Medidas An/AL/Pr	256x275x 251mm	299x310x299mm	330x370x330mm	409x450x409mm	208x450x670mm
Peso	9.2Kg	11.5Kg	15.3Kg	19,5Kg	22.8Kg

Características:

- Woofer y driver de compresión de alto rendimiento.
- Transformador de 70 V/100 V incorporado con interruptor de selección de potencia (ARENA 6CX, 8CX & 10CX).
- Polivinilo resistente al agua. IP54.
- Rejilla con tratamiento hidrofóbico.
- Conector impermeable.
- Soporte en U incluido para la instalación (ARENA 6CX, 8CX, 10CX & 12CX).

CONEXIONES

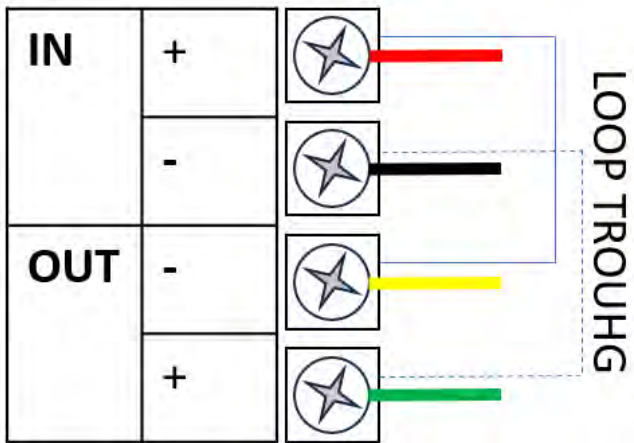



INSTALACIÓN

PRECAUCIONES

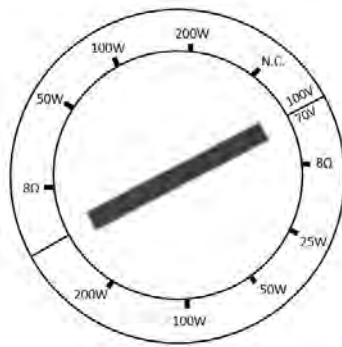

Para conectar a altavoz a línea 70/100V seleccione a la potencia deseada correspondiente a su potencia, para conectar a altavoz en baja impedancia seleccione

MEASURES:

ARENA 6CX

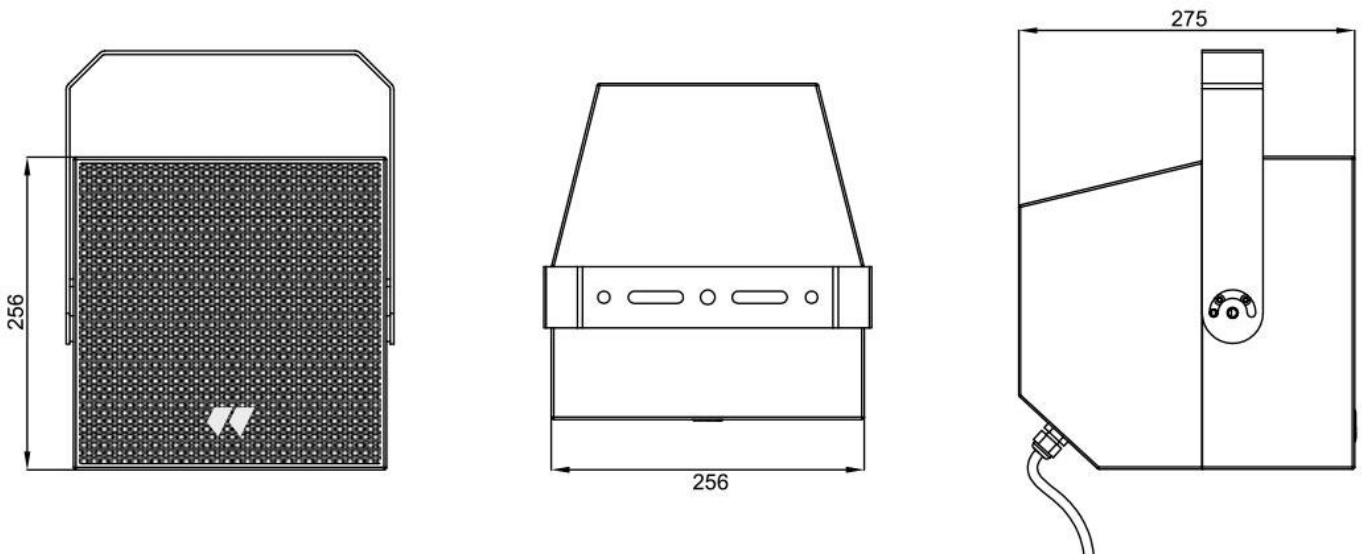

ARENA 8CX

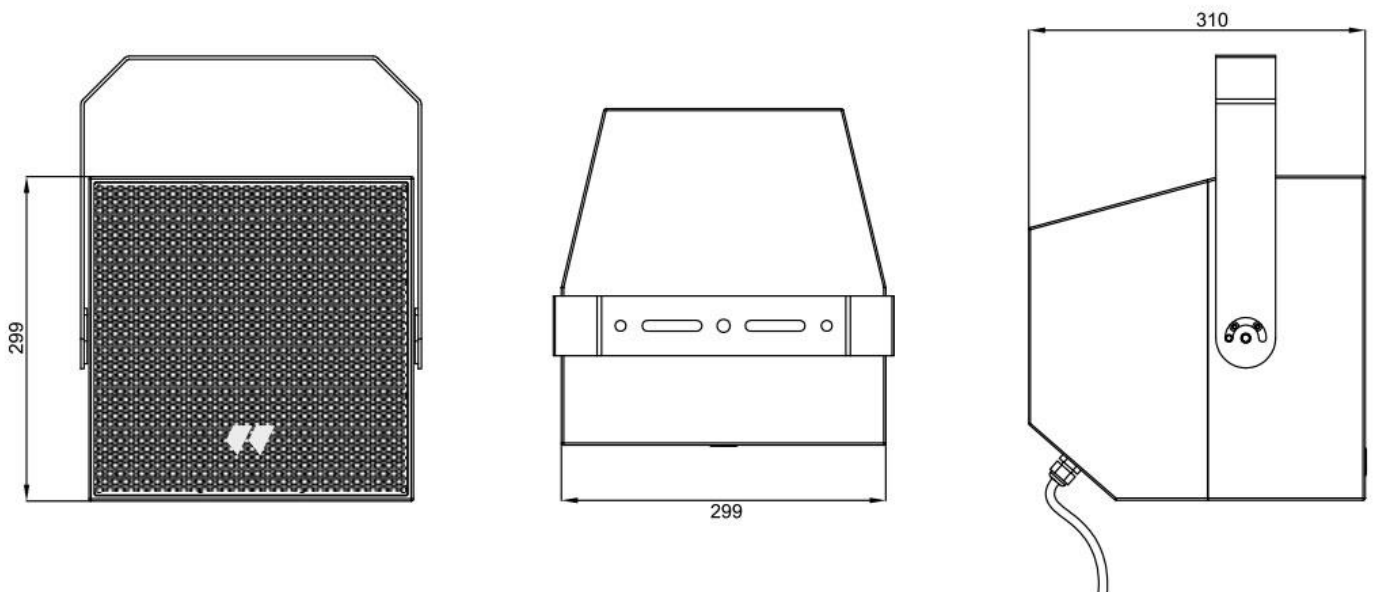

ARENA 10CX

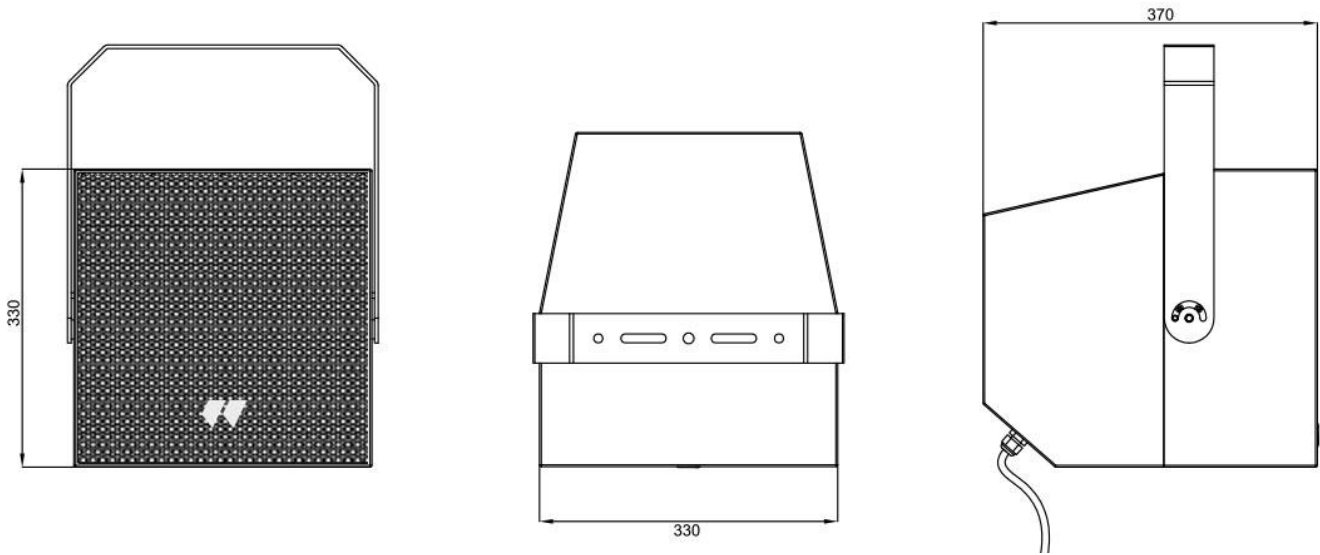

ARENA 12CX

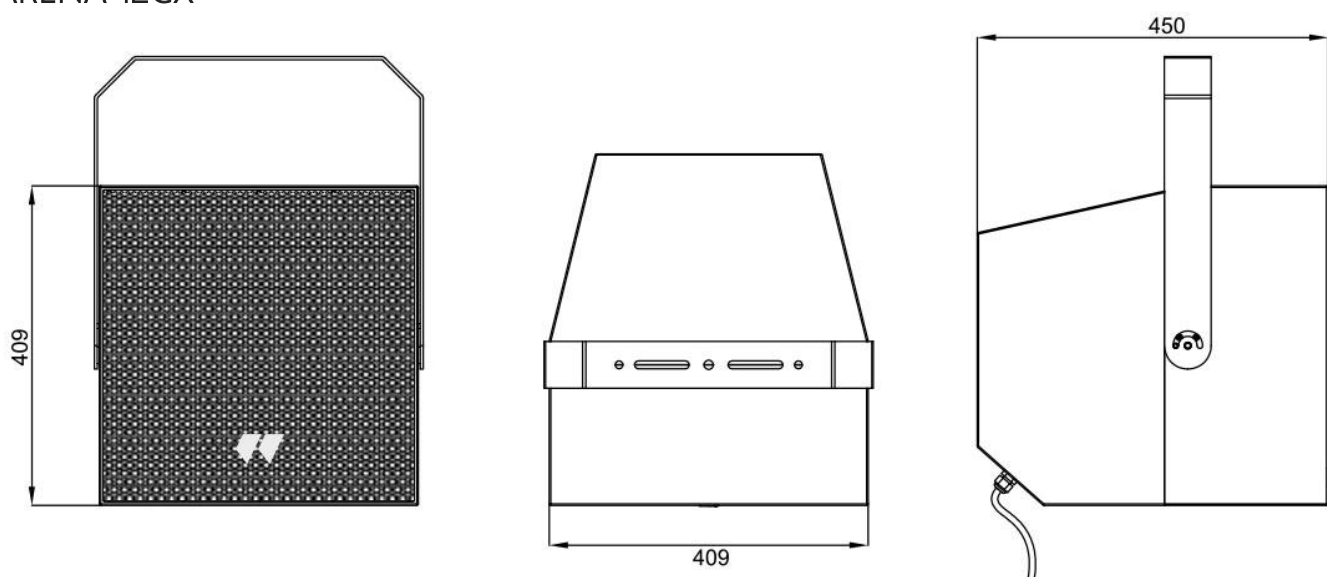

ARENA 28S

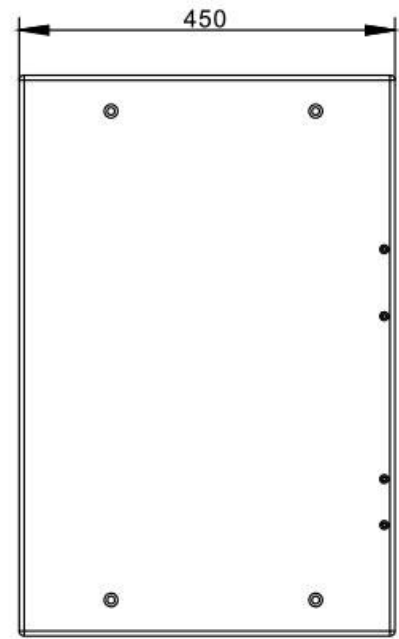
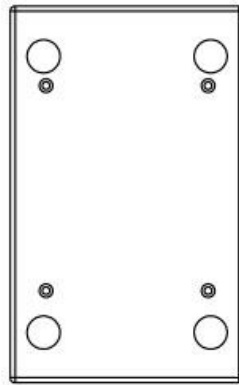
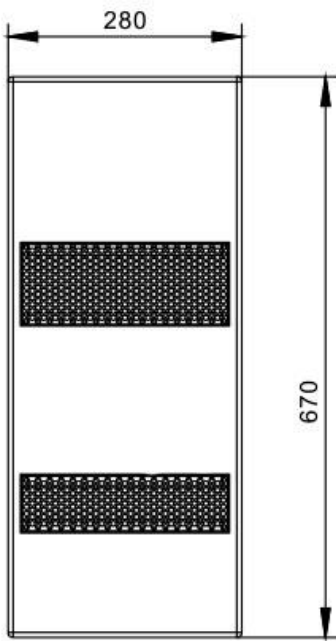



EQUIPSON, S.A.

Avda. El Saler, 14 Pol. Ind. L'Alteró

46460- SILLA

Valencia – Spain

www.equipson.es support@equipson.es