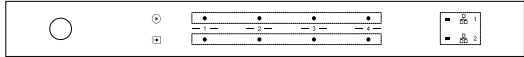

Table of contents

1. Warnings and safety	
2. What's in the box	
3. Introduction	
4. System Requirements	
5. Interface and Functions	
5.1 Front Panel	
5.2 Back Panel	
5.3 Interface	
6. Remote control	
7. Connection diagram	
7.1 How to use	
7.2 App download	
7.3 Connection	
7.4 Connect to USB storage device	
7.5 Connect to audio playback device	
7.6 RS232 Serial Port	
7.7 Connect to network	
8. Download 4Stream APP	
9. Using Smart Zone 4	
9.1 Selecting a zone	
9.2 Play same music to multiple rooms	
9.3 Listen to online music	
9.4 Spotify	
9.5 Airplay	
9.6 Listen to local music	
9.7 Music Playlist	
9.8 Play music from line in	
9.9 Play music from Optical/Coaxial in	
9.10 Play music from PC	
9.11 Changing Output channels	
10. Device Settings	
11. Firmware Update	
12. Specifications	
13. Warranty conditions	



Thank you for buying our Smart Hyde amplifier. We hope you'll enjoy it for years to come. Please read these instructions carefully and keep this manual for later reference. .

1. WARNINGS AND SAFETY

- To prevent fire or electric shocks, the device must not be exposed to rain or humidity.
- For your own safety: to prevent electric shocks do not remove the housing.
- Do not try to repair any malfunctioning parts of the device yourself. Ask a professional expert to do this for you.
- When plugged into the mains, the device remains electrically charged even when switched off.

2. WHAT'S IN THE BOX

Check that the packaging contains the following parts:

- Smart Zone 4
- User Manual
- Ethernet Cable
- Rack Mount Brackets x2
- 12V/2A Power Adapter

SMART ZONE 4

3. INTRODUCTION

The Smart Zone 4 is a multi-room system that enables you to enjoy your favorite music anywhere in your home. Smart Zone 4 contains 4 audio streamers for you to use as audio source, you can easily play music from various online music services, your phone or tablet, NAS and other sources by using the 4Stream app on your iOS or Android device.

- Multi-room audio function: play different music in different rooms or the same music in every room.
- Easy network setup: Connect to your home network and it is ready to use.
- Rich I/O interface: Each zone has both digital and analog inputs and outputs. There is also a master source input that all zones can use.
- Compatible with Artsound Smart Hyde. You can combine the Smart Zone 4 with one or more Smart Hyde amplifiers and control everything from the same app.

4. SYSTEM REQUIREMENTS

HIGH SPEED INTERNET CONNECTION:

The Smart Zone 4 needs a wired ethernet internet connection to stream music from online music services and to get online firmware updates. You may experience performance issues with slower internet connections.

WIRELESS ROUTER:

In order to use the Smart Zone 4, you will need to have a working Wi-Fi network in your home, since the control app on your mobile device needs to be in the same network as the streamer.

CONTROL APP – 4STREAM:

You can control the Smart Zone 4 using our free 4Stream app on any recent iOS and Android device.

5. INTERFACE AND FUNCTIONS

5.1 FRONT PANEL

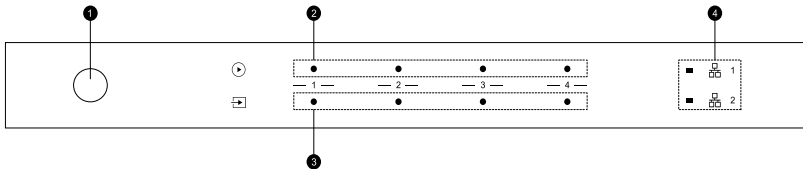

1. Power Button
2. Streaming Indicator – LED on when streaming
3. Input Source Indicator – LED Color: White for Network Audio, Green for Line in 1 (Zone Line in), Yellow for Line in 2 (Master Line in), Magenta for Master Optical in, Cyan for Master Coaxial in, Red for USB
4. Network Indicators – LED on when network is available

5.2 BACK PANEL

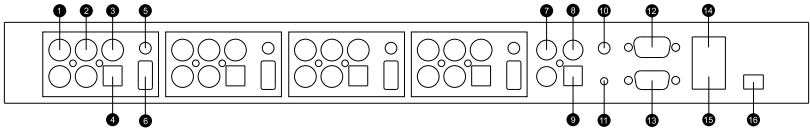

- 1. Pre-Out
- 2. Line In (Line 1 in app)
- 3. Digital Coaxial Out
- 4. Digital Optical Out
- 5. 12v Trigger out
- 6. USB port
- 7. Master Line In (Line in 2 in app)
- 8. Master Digital Coaxial In
- 9. Master Digital Optical In
- 10. Master 12V Trigger out
- 11. Reset button
- 12. Pass Through (RS232 port)
- 13. RS232 Port
- 14. Network input
- 15. Network output
- 16. 1DC input

5.3 BACK PANEL

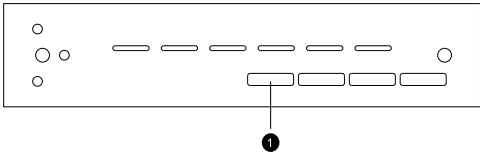

- 1. Zone ID Switch for RS232 port program use.

6. PLACING THE SMART ZONE 4

The Smart Zone 4 is an audio streamer and needs to be used with an external device that offers audio amplification. For example: Artsound AMP1250 or 2 x Artsound PRL1204 can be used. You should place the Smart Zone 4 near the amplification device you want to connect to.

Smart Zone 4 is designed to fit in a 1U equipment rack for easy installation. Attach the included rack mounting brackets on each side of the unit if you want to mount it in a standard 19 inch equipment rack.

- Remove the two screws on each side of the unit
- Align the rack mounting brackets with the screw holes and screw back the screws, make sure they are tightly secured.



7. ZONE CONNECTION

You can play the same audio source in all four zones at the same time, you can also play different audio sources in different zones.

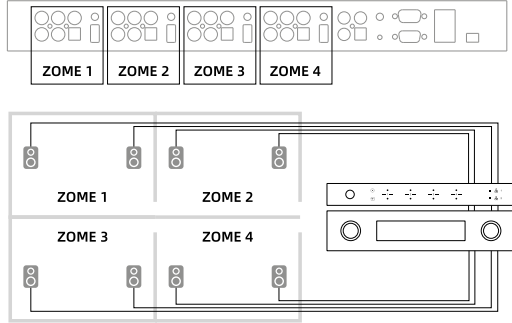

7.1 CONNECT TO EXTERNAL AMPLIFIER OR AV RECEIVER

Connect the LINE OUT output to the input on your amplifier or AV receiver using the appropriate cable. The Smart Zone 4 supports both analog output (RCA) and digital output (Optical & Coaxial).

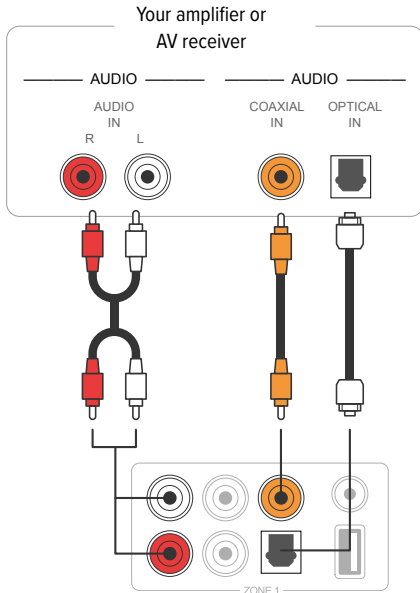

7.2 CONNECT TO EXTERNAL SUBWOOFER

- Connect the LINE OUT “L” output to the input on your active subwoofer or subwoofer amplifier.

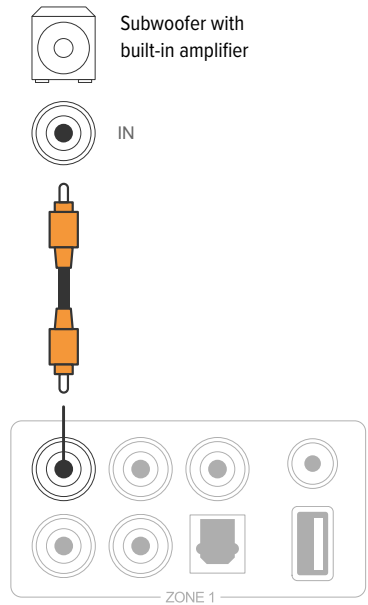

7.3 TRIGGER CONTROL

If the audio amplifier connected to the Smart Zone 4 has a trigger input connector, you can connect it to the TRIGGER OUT of M400 using a 4.5mm cable (not included). A12V/150mA signal is output from the TRIGGER OUT port.

Use a mono mini-plug cable for connecting the TRIGGER OUT port. Do not use a stereo mini-plug cable.

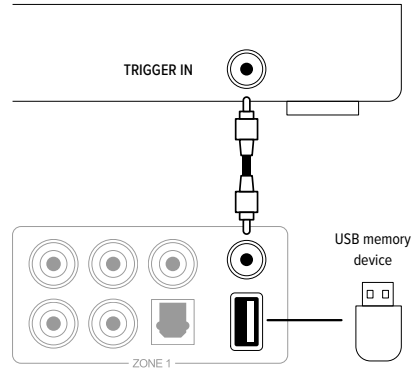

7.4 CONNECT TO USB STORAGE DEVICE

To play music stored on a USB storage device, just plugin a USB storage device containing music files to the USB port of the Zone you want to play it with.

7.5 CONNECT TO AUDIO PLAYBACK DEVICE

Connect the LINE IN in each zone or LINE IN, COAXIAL IN, OPTICAL IN in the master input area to an audio playback device, it can be a TV, CD player, mixer, portable music player or any device with audio output using the same connector.

In the app, LINE IN in each zone is represent as Line in 1, LINE IN in the master input area is represented as Line in 2.

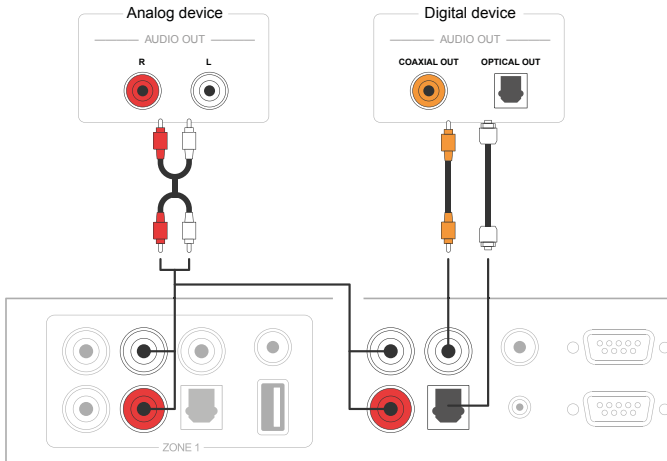

5.6 RS232 SERIAL PORT

RS232 serial port is reserved for connection to smart home control unit to control the Smart Zone 4. You can use the Pass-Through port to connect to another Smart Zone 4 for group control.

The Switches on the side are used to assign a device ID for each zone to let the control unit distinguish each zone.

SMART ZONE 4

7.7 CONNECT TO NETWORK

- Connect the Smart Zone 4 to your home router using a LAN cable to add it into your home network. You can use the NETWORK OUT port to connect another device to the same network.

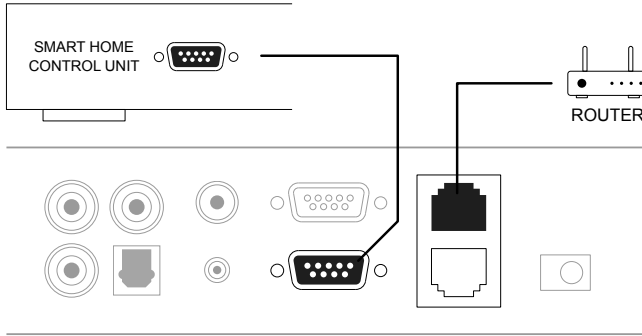

8. DOWNLOAD 4STREAM APP

The 4Stream app is the controller of the whole system. Install 4Stream app in your mobile device and you can control and stream music anywhere in your home. The application supports English, Spanish, French, German, Italian, Portuguese, Korean, Simplified Chinese, Traditional Chinese and Japanese.

You can download 4Stream app for iOS or Android by searching “4Stream” in App Store or Google Play Store.



9. USING THE SMART ZONE 4

Once you have connected your Smart Zone 4 to your network and have installed the 4Stream app on your mobile device, you can start playing music to different rooms. You can listen to different music in different room or the same music in all rooms in sync.

9.1 SELECTING A ZONE

In 4Stream app you will see all the connected devices in the same network.

1. Select the device you want to control, the selected device will have a green bar that appears on the left side.
2. Swipe to the left to open the list of music sources.
3. Select an online or local music source from the list to start streaming your music.

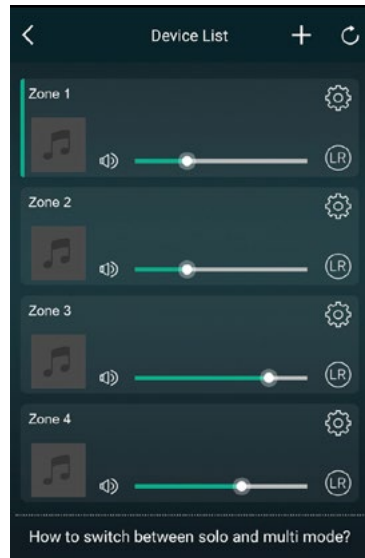

9.2 PLAY SAME MUSIC TO MULTIPLE ROOMS

You can play the same music to multiple rooms simultaneously by pulling a device over another device to from a group. The device list on top of the group is the master device, the music streaming to the master device will also play back on the other devices in the same group.

If your music source is from the master source input, there is no need to group the devices, since all the devices can access the master source input.

*There will be a small delay between the audio source and the 4 zones when in multizone mode, all 4 zones will be in sync with no delay between them.

*There is no delay when you use the master source input as input source for the 4 zones. No need to group them together, ungroup them to play in sync with the input source.

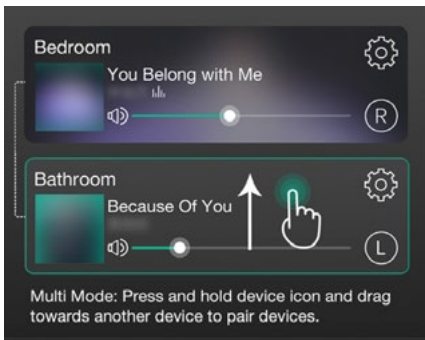

9.3 LISTEN TO ONLINE MUSIC

Smart Zone 4 can work with various online streaming music services like Spotify, Tidal, Qobuz, Deezer, Amazon Music, QQ Music, Tuneln, vTuner Internet radio, iHeartradio. You can easily stream music or playlist from your account wirelessly and play on your home audio system.

9.4 SPOTIFY

To use Spotify, you need to have a Spotify premium account. You will find the different zones from the Smart Zone 4 in the device list in the Spotify application.

9.5 AIRPLAY

The device supports Airplay1, you can choose Airplay in iOS device and play music.

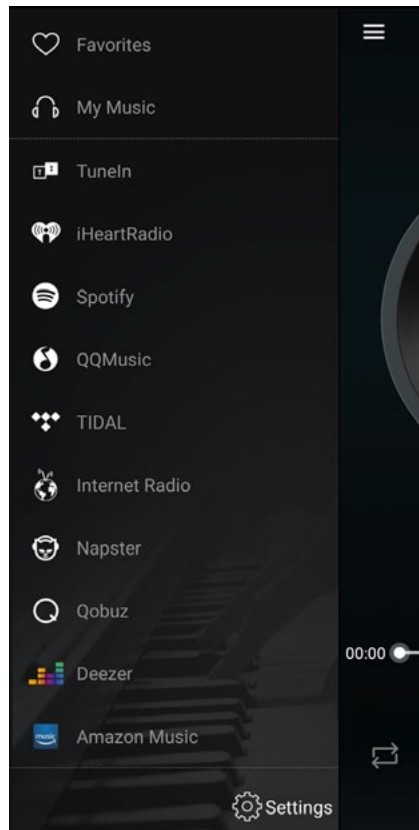

SMART ZONE 4

9.6 LISTEN TO LOCAL MUSIC

Smart Zone 4 can stream local music stored in your mobile phone or tablet, USB storage drive, NAS using DLNA protocol or UPnP/DLNA 3rd party software. Click on “My Music” to select the local device you want to play from.

*Our system only supports NAS systems using DLNA protocol.

9.7 MUSIC PLAYLIST

You can create music a playlist and add local music to the list for streaming.

9.8 PLAY MUSIC FROM LINE IN

- Connect an external audio source to line-in port using RCA cable.
- Choose line in mode in the 4Stream application to switch to line in mode.
- Line in 1 is the line in port of the current zone, Line in 2 is the line in port
- Of the master input source.

9.9 PLAY MUSIC FROM OPTICAL/COAXIAL IN

- Connect an external audio source to Optical/ Coaxial in of the master input source.
- Choose Optical or Coaxial in the 4Stream application to switch to the corresponding mode.

9.10 PLAY MUSIC FROM PC

You can stream audio stored in your Mac and Windows PC by using iTunes, 3rd party UPnP/DLNA streaming program like Foobar2000, Music Bee or Serviio.

9.11 CHANGING OUTPUT CHANNELS

You can change the output channel of the zone, you can change between Left channel only, Right channel only or Stereo. You can set Zone 1 to play Left channel and Zone 2 to play right channel, group them together to make stereo. By default it is set to Stereo.

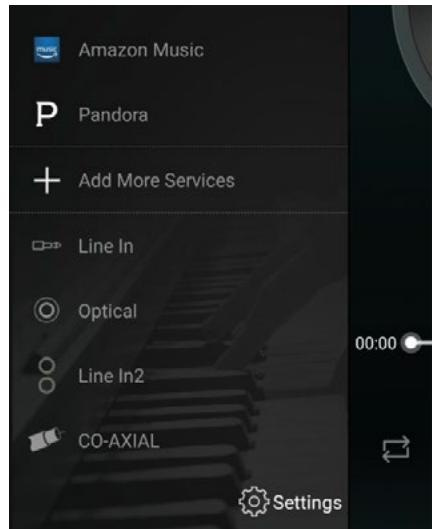
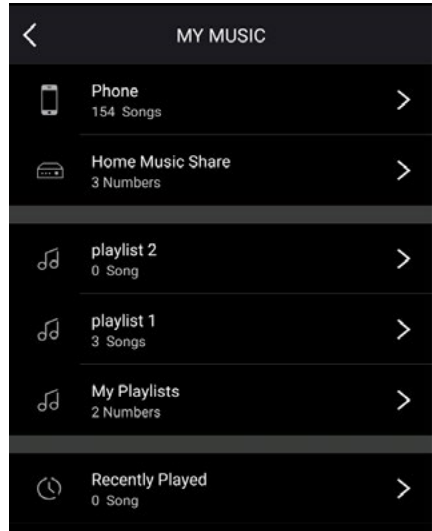

10. DEVICE SETTINGS

RENAME

You can rename each zone to different name to fit your needs.

SPEAKER INFO

You will see the device information like device's IP address, Device name, Firmware Version and Restore Factory Default.

PRESET

You can store 10 different playlist or radio stations to the Preset list for quick access.

Any list or station with the speaker icon can be preset. Click on the speaker icon and you can assign it to the preset list.

RESTORE FACTORY SETTINGS

Long press the Reset button for 8 sec to restore the device to factory default settings.

This will reset all the zone names, volume and current input source.

ALARM CLOCK

Setup music alarm clock, music can come from Preset list, vTuner Internet Radio, iHeartRadio, Napster, Tidal, Spotify, Deezer and NAS

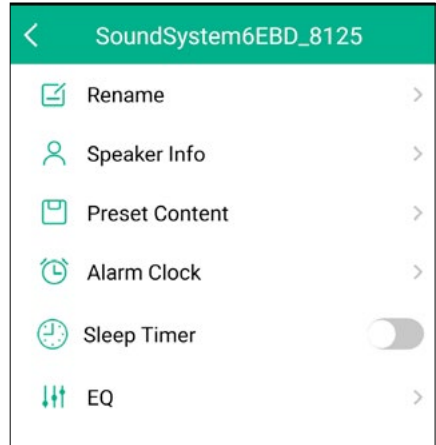

SLEEP TIMER

Setup a Countdown timer to stop the music playback.

EQ

You can control treble and bass of the device.

11. FIRMWARE UPDATE

Whenever a new firmware is available, you will be notified by a “new” icon. Click on the “new” icon to begin firmware update, it will take couple minutes.

It is recommended to update firmware when it is available, it might not only correct bugs or improve performance, but also might add new features or services.

SMART ZONE 4

12. SPECIFICATION

Audio Input	Line in	Max 2V RMS input
	USB	USB Playback
Audio Output	Line out	Max 2V RMS output
	SPDIF Optical	44.1KHz/16Bit output, multiroom function
	SPDIF Coaxial	
Master Input Source		
Audio Input	Line in	Max 2V RMS input
	SPDIF Optical	Max 192KHz/24Bit Sample Rate Decode
	SPDIF Coaxial	PCM encoding
Network		
Ethernet In	RJ45	
Ethernet Out	RJ45	Output to other device to share the network
General		
Power	12V DC in (12V/2A)	
	Master Trigger Output, Trigger Output on each zone	
Control Interface	Dual-way RS232	
Size	43x20x4.5 (5.3 with footer) cm	

13. WARRANTY CONDITIONS

2 year warranty from date of purchase. The warranty is limited to the repair or replacement of the defective material insofar as this defect is a result of normal use and the device has not been damaged. Artsound is not responsible for any other costs that ensue as a result of the defect (e.g. transport). For details, please consult our general terms and conditions of sale.



To prolong battery lifespan, fully charge at least once every 3 months. Battery life will vary due to usage patterns and environmental conditions. Do not expose to liquids without removing all cable connections and close the cap tightly. Do not expose to liquids while charging. It may result in permanent damage to the speaker or power source. Do not use or place near a heat source.



This product bears the selective sorting symbol for waste electrical and electronic equipment (WEEE). This means that this product must be handled pursuant to European Directive 2002/96/EC in order to be recycled or dismantled to minimize its impact on the environment. For further information, please contact your local or regional authorities.





I, House Of Music NV, hereby declare that the type of radio equipment ARTSOUND complies with Directive 2014/53/EU. The full text of the EU Declaration of Conformity can be found at the following internet address: <http://www.artsound.be/en/support/downloads>

Disclaimer: All trademarks are the property of their respective owners. All specifications and information are subject to change without further notice. Slight variations and differences might appear between printed photos and actual product due to product enhancement.

House Of Music NV - Schoonboeke 10 B-9600 Ronse - Belgium

artsound

smart solutions in audio

 www.artsound.be
 [Artsound.audio](https://www.facebook.com/Artsound.audio)
 [artsoundaudio](https://www.instagram.com/artsoundaudio)

artsound
smart solutions in audio

sa House of Music nv
Ronse, Belgium
 +32 9 380 81 80
 info@houseofmusic.be