

1. Alerts and safety!	1
2. Contents of the box	1
3. Introduction	1
4. System requirements	2
5. Interface and functions	2
6. Diagram	2
7. Downloading the 4Stream app	3
8. Installation	3
8.1 First use via wireless setup	3
8.2 Connection via LAN	3
8.3 Connection via Bluetooth	3
9. Functions of the app	4
9.1 Device settings	4
9.2 Playing local music	4
9.3 Playing music from line in	5
9.4 Playing music via Bluetooth	5
9.5 Using music services	5
9.6 Spotify	5
9.7 Airplay	5

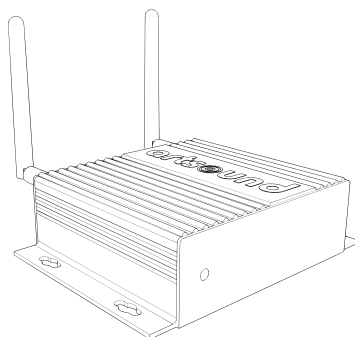

9.8 Multiroom and multizone	6
9.9 Choice of source	6
9.10 Resetting the factory settings	6
9.11 Updating firmware	6
10. Specifications	7
11. Warranty conditions	7

Thank you for buying our Smart Stream. We hope you'll enjoy it for years to come. Please read these instructions carefully and keep this manual for later reference.

1. WARNINGS AND SAFETY

- To prevent fire or electric shocks, the device must not be exposed to rain or humidity.
- For your own safety: to prevent electric shocks do not remove the housing.
- Do not try to repair any malfunctioning parts of the device yourself. Ask a professional expert to do this for you.
- When plugged into the mains, the device remains electrically charged even when switched off.

2. CONTENTS OF THE BOX

Check whether the box contains the following components:

- Smart Stream
- User instructions
- 2 x antennas for Wi-Fi and Bluetooth
- 2 x RCA-cables
- 12V/1A Power adapter

3. INTRODUCTION

The Smart Stream is a high-quality streaming pre-amplifier with network and Bluetooth-connectivity. By connecting the Smart Stream to your current stereo-system, you can stream music from your smartphone, tablet, USB, NAS or from streaming services, such as Spotify, Tidal or Qobuz. Use the 4STREAM app, or stream via AirPlay and Bluetooth.

The Smart Stream is a multi-room system that allows you to enjoy your favourite music anywhere in your home.

4. SYSTEM REQUIREMENTS

The Smart Stream requires a wired or wireless internet connection to be able to stream music from online music services and to get access to online firmware updates. The performance could be less favourable in case of a slower internet connection.

WIRELESS ROUTER

To make use of Smart Stream, you will need a functioning Wi-Fi network in your home, since the control app on your mobile device should be connected to the same network as the streamer.

CONTROL APP – 4STREAM

You can control the Smart Stream using our free 4Stream app on a recent iOS- or Android device.

5. INTERFACE AND FUNCTIONS

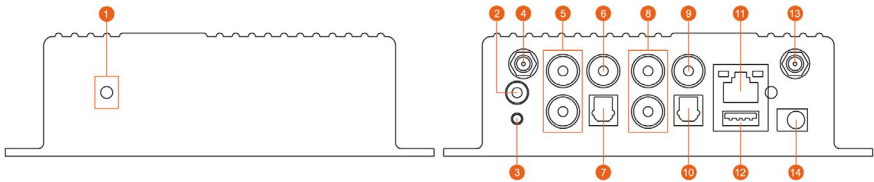

- 1. LED: to indicate the status of the device.
- 2. rigger: 12V trigger output for use in combination with other devices.
- 3. Reset: press briefly to reset Wi-Fi, hold to reset the device to factory settings.
- 4. Bluetooth antenna: external Bluetooth antenna for better Bluetooth signal strength.
- 5. Line input: for external audio sources like TV, CD-player, etc.
- 6. Sub-output: for connecting an active subwoofer.
- 7. OPTICAL IN: for digital input source.
- 8. Line output: for analogue audio-output to an external device.
- 9. COAX OUT: for coaxial digital audio-output to an external device.
- 10. OPTICAL OUT: for optical digital audio-output.
- 11. LAN: wired connection to your router.
- 12. USB: connection for USB-mass storage (1024 tracks maximum).
- 13. Wi-Fi-antenna: external Wi-Fi-antenna.
- 14. DC in: 12V/1A DC input.

6. DIAGRAM

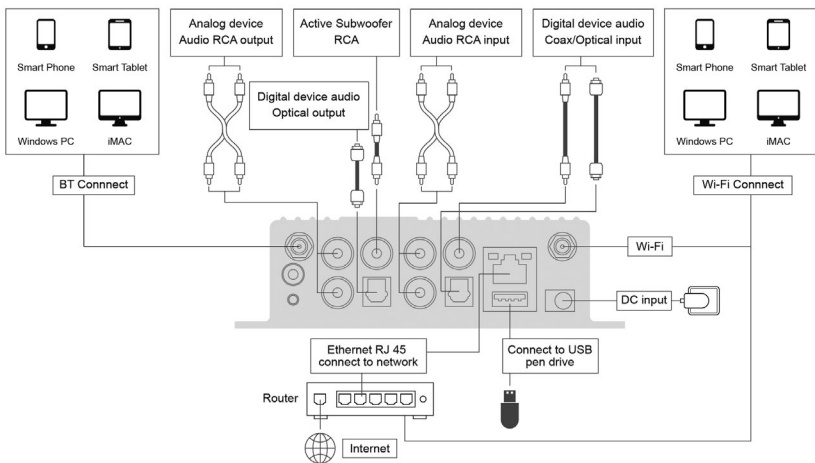

7. DOWNLOADING THE 4STREAM APP

Download the 4 Stream-app from the App Store for iOS-devices or Google Play Store for Android-devices. The app is explained in different languages, including English, French, German, Italian, Spanish and Portuguese.

8. INSTALLATION

8.1 FIRST USE VIA WIRELESS SETUP

1. Hold the RESET-button and then connect the power cable.
2. The LED will start flashing rapidly, release the button and wait until the light flashes slowly.
3. Make sure that your mobile phone is connected to your home network via Wi-Fi (2.4GHz) and that your GPS and Bluetooth are on.
4. Open the 4Stream app. On the Android-devices, the system will ask permission for GPS & Storage, click "Accept" to continue. The GPS-permission is required only during installation, you can switch it off again later on. Permission for storage of files serves to allow 4Stream access to the local music files on your device.
5. The 4Stream app will show a list of all devices available for installation, select the one you wish to install.
6. The 4Stream app will ask you which network you wish to connect to.
7. Now enter the password for your network.
8. As soon as the connection is completed, there will be a check on new software updates for the Smart Stream.
9. Then you can change the name of the device. You can choose a pre-selected name or enter your own name.
10. After setting the name of the device, this will appear in the list of devices in the 4Stream app and you can start streaming music.

There is another way of installing via Wi-Fi, should the method explained above not work:

1. Hold the RESET-button and connect the power cable.
2. The LED will start flashing rapidly, release the button and wait until the light flashes slowly.
3. Go to your mobile Wi-Fi-setting and search for SmartStream_xxxx Wifi and connect.
4. Open the 4Stream app and you should be able to see the SmartStream_xxxx in the list of devices.
*Your device may ask you whether you wish to keep using this Wi-Fi connection, click Yes.
5. 6) Click the "+" icon in the top right corner to add the device. The app will ask you to select your wireless network. If necessary, enter the password and click on Connect.
6. Once connected, you can change the name of the Smart Stream. You can choose a pre-selected name or enter your own name. This is mainly convenient in case multiple Smart-devices are being used.
7. After setting the name of the Smart Stream, this will appear in the list of devices in the 4Stream app.

8.2 CONNECTION VIA LAN

Connect the network cable to the RJ45 Ethernet port indicating LAN. The Smart Stream will appear in the app after about 10 seconds.

(Remark: The mobile phone and the device must be situated in the same network)

8.3 CONNECTION VIA BLUETOOTH

Switch to the Bluetooth mode by pressing Bluetooth in the app. Now look for the device SmartStream_XXXX in the Bluetooth settings and make the connection.

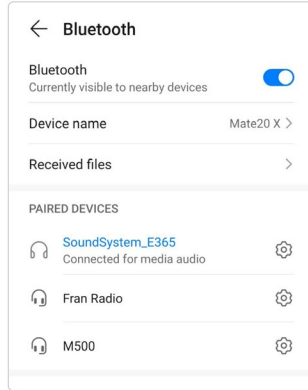
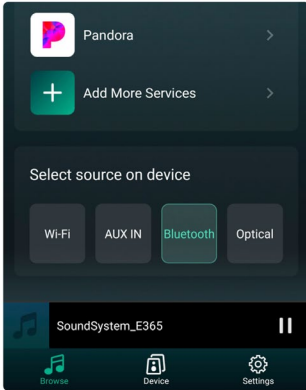

9. FUNCTIONS OF THE APP

As soon as you have connected the Smart Stream to the network, and installed the 4Stream app on your device, you can start playing music. You can listen to different music in different rooms, or apply synchronised music in all rooms (if different Smart-devices are being used).

You can control the device by clicking on its name in the app.

9.1 DEVICE SETTINGS

Clicking on the settings icon, you can change various settings of the Smart Stream:

VISUAL OF SETTINGS SCREEN

RENAME: You can rename the device.

SPEAKER INFO: This is where the device's information is shown, such as the IP-address, the name and the firmware version. You can also reset the factory settings here.

ALARM CLOCK: You can set up to 4 different alarms, with the music of your choice.

PRESET CONTENT: It is possible to store up to 10 different playlists.

SLEEP TIMER: Set a timer to stop music playing at a chosen time.

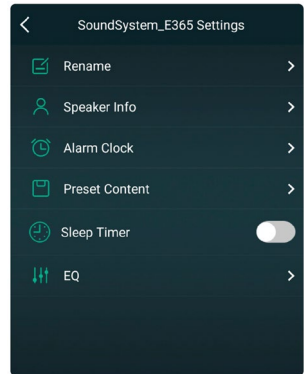

9.2 PLAYING LOCAL MUSIC

The Smart Stream is able to play local music stored on your telephone or tablet, a USB-storage device, NAS, using the DLNA protocol or a third party's UPnP/DLNA software.

Click on "My Music" to select the music you wish to play.

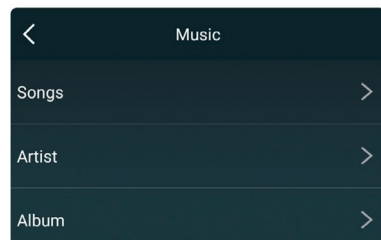
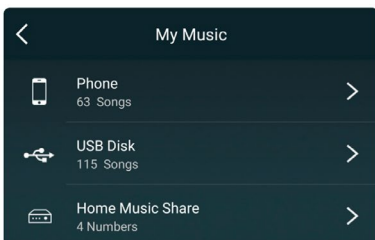

9.3 PLAYING MUSIC FROM LINE IN

Connect an external audio source to the line-in port by use of an RCA-cable. Click on the line in-button at the bottom of the 'Browse'-screen in the 4Stream app, to switch to the line in-mode.

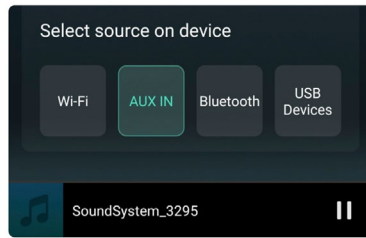

9.4 PLAYING MUSIC VIA BLUETOOTH

Click on the Bluetooth-button at the bottom of the 'Browse'-screen. The LED will start flashing in blue. On your smartphone or tablet, look for the Smart Stream and connect. The LED-light will now light up in blue and stop flashing.

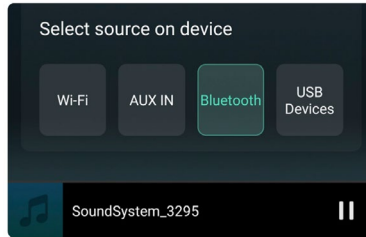

9.5 USING MUSIC SERVICES

Smart Stream is able to cooperate with different online streaming music services, such as Spotify, Tidal, Qobuz, Deezer, Amazon Music, QQ Music, Tuneln, vTuner Internalt radio, iHeartradio and many others. You may need to make use of a paid account for some of them.

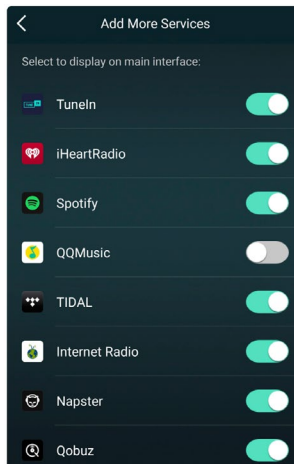
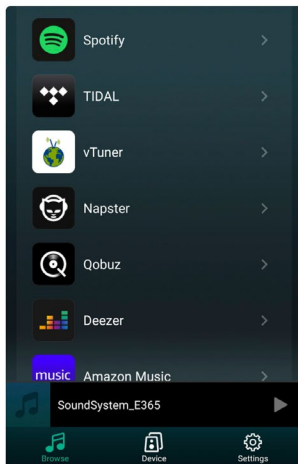

9.6 SPOTIFY

To be able to use Spotify, you will need a Spotify premium account. You can find the Smart Stream in the device list of the Spotify app.

9.7 AIRPLAY

The device supports Airplay1, select Airplay in your iOS-device or Mac and play music.

9.8 MULTIROOM AND MULTIZONE

Users are able to group multiple rooms and zones in the application. You can, for instance, group devices 1, 2 and 3 to synchronously play the same music, or group devices 1 and 2 as zone A and devices 3 and 4 as zone B, and play different music in zones A and B.

Please note: this is possible only when using different ArtSound Smart-devices!

In order to group a device, you click on the “+” sign of the device that you wish to use as master device.

A list will appear containing available devices and now you can select the device or devices that you wish to add. Click on the Ready button once you are finished. The grey check mark represents the master-device and the green check mark represent the slave-device.

To remove a device from the group, you click on the “+” sign once more, to have the list of devices shown, and remove the desired device(s). Then click on the Ready button to confirm.

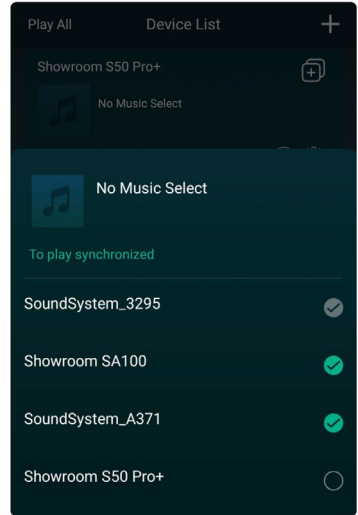

9.9 CHOICE OF SOURCE

Method 1: by pressing the desired button at the bottom of the ‘Browse’ screen.

Method 2: by briefly pressing the Reset-button on the device, the Smart Stream will switch from one source to the other.

9.10 RESETTING THE FACTORY SETTINGS

Hold the Reset button (for 8 seconds) to restore the device to the factory settings.

9.11 UPDATING FIRMWARE

If new firmware becomes available, you will be informed by means of a notification. Click on the notification to start the firmware update. This will take several minutes. It is recommended to update the firmware when an update becomes available. Not only will this correct bugs in the performance, but also it is possible that new functions or services are added.

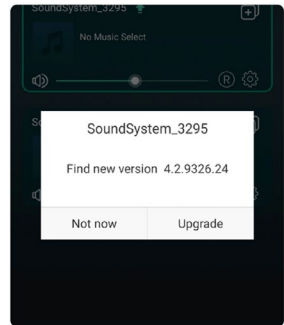
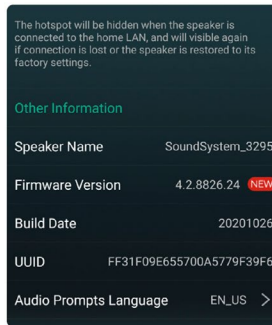
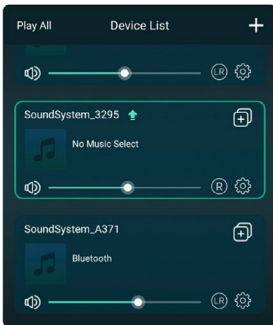

10. SPECIFICATIONS

description	compact streaming pre-amplifier
internet radio	Internet radio: > 10,000 stations worldwide
music services:	Spotify Connect, Tuneln, vTuner, Deezer, Tidal, Qobuz, ... AirPlay, Bluetooth 5.0, NAS via UPnP/dlna
input	stereo RCA, optical, USB (mass storage)
output	stereo RCA, coax, optical, subwoofer out
functions	Alarm clock function, sleep timer
internet connection	ethernet RJ45, 2.4G Wi-Fi
control	4Stream app (iOS + Android), API, 12V trigger out
power supply	12V/1A DC
measurements (h x w x d)	41x 148x 120mm
weight	0.37kg

10. WARRANTY CONDITIONS

2 year warranty from date of purchase. The warranty is limited to the repair or replacement of the defective material insofar as this defect is a result of normal use and the device has not been damaged. Artsound is not responsible for any other costs that ensue as a result of the defect (e.g. transport). For details, please consult our general terms and conditions of sale.



This product bears the selective sorting symbol for waste electrical and electronic equipment (WEEE). This means that this product must be handled pursuant to European Directive 2002/96/EC in order to be recycled or dismantled to minimize its impact on the environment. For further information, please contact your local or regional authorities.





I, House Of Music NV, hereby declare that the type of radio equipment ARTSOUND complies with Directive 2014/53/EU. The full text of the EU Declaration of Conformity can be found at the following internet address: <http://www.artsound.be/en/support/downloads>

Disclaimer: Alle handelsmerken zijn het eigendom van hun respectievelijke eigenaars. Alle specificaties en informatie zijn onderworpen aan wijzigingen zonder verdere kennisgeving. Kleine variaties en verschillen tussen de geprinte foto's en het product zelf zijn mogelijk omwille van productverbetering.
House Of Music NV - Legen Heirweg 23D, B-9890 Gavere

House of Music nv, Legen Heirweg 23D, B-9890 Gavere

 www.artsound.be

 [artsoundaudio](https://www.instagram.com/artsoundaudio)

 info@artsound.be

 [artsound.audio](https://www.facebook.com/artsound.audio)

artsound
we speak sound